



I-Tech Series

Operation Manual



I-T4000

I-T6000

I-T8000

Obtaining Other Language Versions: To obtain information in another language about the use of this product, please contact your local Crown Distributor. If you need assistance locating your local distributor, please contact Crown at 574-294-8000.

This manual does not include all of the details of design, production, or variations of the equipment. Nor does it cover every possible situation which may arise during installation, operation or maintenance.

The information provided in this manual was deemed accurate as of the publication date. However, updates to this information may have occurred. To obtain the latest version of this manual, please visit the Crown website at www.crownaudio.com.

Trademark Notice: Crown, Crown Audio, IQ, IQ System, BCA, and Amcron are registered trademarks of Crown International. IQwic and TCP/IQ are trademarks of Crown International. HiQnet is a trademark of Harman International Industries, Inc. Other trademarks are the property of their respective owners.

Some models may be exported under the name Amcron.®

©2007 by Crown Audio® Inc., 1718 W. Mishawaka Rd., Elkhart, Indiana 46517-9439 U.S.A. Telephone: 574-294-8000

137289-10
11/07

Important Safety Instructions

Importantes Instrucciones de Seguridad

- 1) Read these instructions.
- 2) Keep these instructions.
- 3) Heed all warnings.
- 4) Follow all instructions.
- 5) Do not use this apparatus near water.
- 6) Clean only with a dry cloth.
- 7) Do not block any ventilation openings. Install in accordance with the manufacturer's instructions.
- 8) Do not install near any heat sources such as radiators, heat registers, stoves, or other apparatus (including amplifiers) that produce heat.
- 9) Do not defeat the safety purpose of the polarized or grounding-type plug. A polarized plug has two blades with one wider than the other. A grounding-type plug has two blades and a third grounding prong. The wide blade or the third prong is provided for your safety. If the provided plug does not fit into your outlet, consult an electrician for replacement of the obsolete outlet.
- 10) Protect the power cord from being walked on or pinched, particularly at plugs, convenience receptacles, and the point where they exit from the apparatus.
- 11) Only use attachments/accessories specified by the manufacturer.
- 12) Use only with a cart, stand, tripod, bracket, or table specified by the manufacturer, or sold with the apparatus. When a cart is used, use caution when moving the cart/apparatus combination to avoid injury from tip-over.
- 13) Unplug this apparatus during lightning storms or when unused for long periods of time.
- 14) Refer all servicing to qualified service personnel. Servicing is required when the apparatus has been damaged in any way, such as power-supply cord or plug is damaged, liquid has been spilled or objects have fallen into the apparatus, the apparatus has been exposed to rain or moisture, does not operate normally, or has been dropped.
- 15) Use the mains plug to disconnect the apparatus from the mains.
- 16) **WARNING: TO REDUCE THE RISK OF FIRE OR ELECTRIC SHOCK, DO NOT EXPOSE THIS APPARATUS TO RAIN OR MOISTURE.**
- 17) **DO NOT EXPOSE THIS EQUIPMENT TO DRIPPING OR SPLASHING AND ENSURE THAT NO OBJECTS FILLED WITH LIQUIDS, SUCH AS VASES, ARE PLACED ON THE EQUIPMENT.**
- 18) **THE MAINS PLUG OF THE POWER SUPPLY CORD SHALL REMAIN READILY OPERABLE.**



Wichtige Sicherheitsinstruktionen

Instrucciones de Seguridad Importantes

TO PREVENT ELECTRIC SHOCK DO NOT REMOVE TOP OR BOTTOM COVERS. NO USER SERVICEABLE PARTS INSIDE. REFER SERVICING TO QUALIFIED SERVICE PERSONNEL.

À PRÉVENIR LE CHOC ÉLECTRIQUE N'ENLEVEZ PAS LES COUVERCLES. IL N'Y A PAS DES PARTIES SERVICEABLE À L'INTÉRIEUR. TOUTS REPARATIONS DOIT ÊTRE FAIRE PAR PERSONNEL QUALIFIÉ SEULMENT.

PARA PREVENIR UN CHOQUE ELÉCTRICO, NO RETIRE LAS CUBIERTAS SUPERIOR O INFERIOR. NO EXISTEN PARTES QUE PUEDAN SER REPARADAS POR EL USUARIO AL INTERIOR. REMITA EL SERVICIO AL PERSONAL TÉCNICO CALIFICADO.

TO COMPLETELY DISCONNECT THIS EQUIPMENT FROM THE AC MAINS, DISCONNECT THE POWER SUPPLY CORD PLUG FROM THE AC RECEPTACLE. THE MAINS PLUG OF THE POWER SUPPLY CORD SHALL REMAIN READILY OPERABLE.

POUR DÉMONTER COMPLÈTEMENT L'ÉQUIPEMENT DE L'ALIMENTATION GÉNÉRALE, DÉMONTER LE CÂBLE D'ALIMENTATION DE SON RÉCEPTACLE. LA PRISE D'ALIMENTATION RESTERA AISÉMENT FONCTIONNELLE.

PARA DESCONECTAR COMPLETAMENTE EL EQUIPO DEL SUMINISTRO ELÉCTRICO, DESCONECTE EL CABLE DE ALIMENTACION DE LA TOMA DE CA. LAS PATAS DEL CONECTOR DEL CABLE DE ALIMENTACION DEBERAN MANTENERSE EN BUEN ESTADO.

WATCH FOR THESE SYMBOLS:

The lightning bolt triangle is used to alert the user to the risk of electric shock.

The exclamation point triangle is used to alert the user to important operating or maintenance instructions.

REGARDEZ CES SYMBOLES

La triangle avec le sigle "foudre" est employée pour alerter l'utilisateur au risque de décharge électrique. Le triangle avec un point d'exclamation est employée pour alerter l'utilisateur d'instruction importantes pour lors opérations de maintenance.

ATENCION CON ESTOS SÍMBOLOS

El triángulo con el símbolo de rayo eléctrico es usado para alertar al usuario de el riesgo de un choque eléctrico.

El triángulo con el signo de admiración es usado para alertar al usuario de instrucciones importantes de operación o mantenimiento.



CAUTION
RISK OF ELECTRIC SHOCK
DO NOT OPEN



AVIS
RISQUE DE CHOC ÉLECTRIQUE
N'OUVREZ PAS



The I-Tech Series amplifiers are certified only at 120V \sim in Canada.

IMPORTANT

I-Tech Series amplifiers require Class 2 output wiring. Les amplificateurs de série de I-Tech exigent des câbles de sortie de classe 2. I-Tech-Reihe-Verstärker verlangen Klasse die 2 Produktionsverdrahtung. Los amplificadores de la Serie I-tech requieren de un cableado de salida Clase 2.

MAGNETIC FIELD

CAUTION! Do not locate sensitive high-gain equipment such as preamplifiers or tape decks directly above or below the unit. Because this amplifier has a high power density, it has a strong magnetic field which can induce hum into unshielded devices that are located nearby. The field is strongest just above and below the unit.

If an equipment rack is used, we recommend locating the amplifier(s) in the bottom of the rack and the preamplifier or other sensitive equipment at the top.

FCC COMPLIANCE NOTICE

This device complies with part 15 of the FCC rules. Operation is subject to the following two conditions: (1) This device may not cause harmful interference, and (2) this device must accept any interference received, including interference that may cause undesired operation.

CAUTION: Changes or modifications not expressly approved by the party responsible for compliance could void the user's authority to operate the equipment.

NOTE: This equipment has been tested and found to comply with the limits for a Class B digital device, pursuant to part 15 of the FCC Rules. These limits are designed to provide reasonable protection against harmful interference in a residential installation. This equipment generates, uses, and can radiate radio frequency energy and, if not installed and used in accordance with the instruction manual, may cause harmful interference to radio communications. However, there is no guarantee that interference will not occur in a particular installation. If this equipment does cause harmful interference to radio or television reception, which can be determined by turning the equipment off and on, the user is encouraged to try to correct the interference by one or more of the following measures:

- Reorient or relocate the receiving antenna.
- Increase the separation between the equipment and receiver.
- Connect the equipment into an outlet on a circuit different from that to which the receiver is connected.
- Consult the dealer or an experienced radio/TV technician for help.

Crown International, Inc.

DECLARATION of CONFORMITY

ISSUED BY: Crown International, Inc.
1718 W. Mishawaka Road
Elkhart, Indiana 46517 U.S.A.

FOR COMPLIANCE QUESTIONS ONLY: Sue Whitfield
574-294-8289
swhitfield@crowintl.com

European Representative's Name and Address:

David Budge
10 Harvest Close
Yateley GU46 6YS
United Kingdom

Equipment Type: Commercial Audio Power Amplifiers

Family Name: I-Tech

Model Names: I-T4000, I-T6000, I-T8000

EMC Standards:

EN 55103-1:1997 Electromagnetic Compatibility - Product Family Standard for Audio, Video, Audio-Visual and Entertainment Lighting Control Apparatus for Professional Use, Part 1: Emissions

EN 55103-1:1997 Magnetic Field Emissions-Annex A @ 10 cm and 20 cm

EN 61000-3-2:2001 Limits for Harmonic Current Emissions (equipment input current less than or equal to 16 A per phase)

EN 61000-3-3:2002 Limitation of Voltage Fluctuations and Flicker in Low-Voltage Supply Systems Rated Current less than or equal to 16A

EN 55022:2003 Limits and Methods of Measurement of Radio Disturbance Characteristics of ITE: Radiated, Class B Limits; Conducted, Class A

EN 55103-2:1997 Electromagnetic Compatibility - Product Family Standard for Audio, Video, Audio-Visual and Entertainment Lighting Control Apparatus for Professional Use, Part 2: Immunity

EN 61000-4-2:2001 Electrostatic Discharge Immunity (Environment E2-Criteria B, 4k V Contact, 8k V Air Discharge)

EN 61000-4-3:2001 Radiated, Radio-Frequency, Electromagnetic Immunity (Environment E2, criteria A)

EN 61000-4-4:2001 Electrical Fast Transient/Burst Immunity (Criteria B)

EN 61000-4-5:2001 Surge Immunity (Criteria B)

EN 61000-4-6:2003 Immunity to Conducted Disturbances Induced by Radio-Frequency Fields (Criteria A)

EN 61000-4-11:2001 Voltage Dips, Short Interruptions and Voltage Variation

Safety Standard:

IEC 60065: 2001 7th Ed. Safety Requirements - Audio Video and Similar Electronic Apparatus

I certify that the product identified above conforms to the requirements of the EMC Council Directive 89/336/EEC as amended by 92/31/EEC, and the Low Voltage Directive 73/23/EES as amended by 93/68/EEC.

Signed

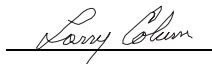

Title: Senior Vice President of Manufacturing

Date of Issue: May 1, 2004

Getting Started With I-Tech

Welcome! Operating your I-Tech amplifier can be as simple or advanced as you wish. Right out of the box, it works like any other amplifier with stereo loudspeaker loads.

- For bridge-mono operation, see page 5.
- If you want to control and monitor the amplifier with Crown's IQ System® software, see Section 4.5.4. If you are going to use SystemArchitect, please follow the information included with System Architect.
- If you want to load DSP presets or perform diagnostics using the amplifier's LCD control screen (Figure A.3), see Section 4.2.

You can refer to this Quick-Start Guide to get up and running quickly. To learn about I-Tech's many advanced features, please see the rest of this manual.

Quick-Start Guide: Stereo Wiring

Let's assume that you unpacked and installed your amplifier with the proper cooling. If not, see Section 2 in this manual. We'll also assume that you will operate the amplifier in stereo. If you want to operate your amplifier in bridge-mono, skip to page 5.

1. IMPORTANT: Turn off the amplifier. Unplug its power cord from the AC outlet. The amplifier must be grounded when plugged into AC power.



2. See Figure A.1. Connect two cables from your mixer output to the amplifier's XLR input connectors.

3. Using Class 2 wiring, connect speaker cables either to the amplifier's Speakon® connectors (as in Figure A.2) or to the binding posts (as in Figure A.1.)

4. Turn down your mixer master faders. Plug the power cord into the amplifier and then into an AC outlet. Turn on the front-panel power switch. The LCD Control Screen will light up (Figure A.3).

5. Using both Encoder knobs (Level controls), set Attenuation to 0 dB. Press the **Menu/Exit** button, then the **Next** button, to access CH1 Sensitivity. Turn an Encoder knob fully down (CCW) until the minimum dB gain is displayed. Then press **Next** and repeat for CH2 Sensitivity. See Appendix B for details.

6. Play a program through your mixer. Set its level to peak at 0 dB or 0 VU maximum on the mixer meters. Gradually turn up (CW) the amplifier Encoder knobs (Level controls) to the desired volume for CH2. Press **Prev** and repeat for CH1. Press **Exit** when done.

Note: If the SPL is too high at the beginning of Step 6, press **Menu/Exit**, then press **Next** until you see ADVANCED MENU. Push an Encoder knob. Press **Next** until you see MAXIMUM ANALOG INPUT. Press an Encoder knob so the display reads 21 dBu. Press **Menu/Exit** twice. Press **Next**. CH1 Sensitivity will be displayed. Gradually turn up (CW) the left Encoder knob to the desired volume for CH1. Press **Next** and repeat for CH2. Press **Exit** when done.

CAUTION – SHOCK HAZARD: Potentially lethal voltages exist at the output connectors when the amplifier is turned on and is passing a signal.

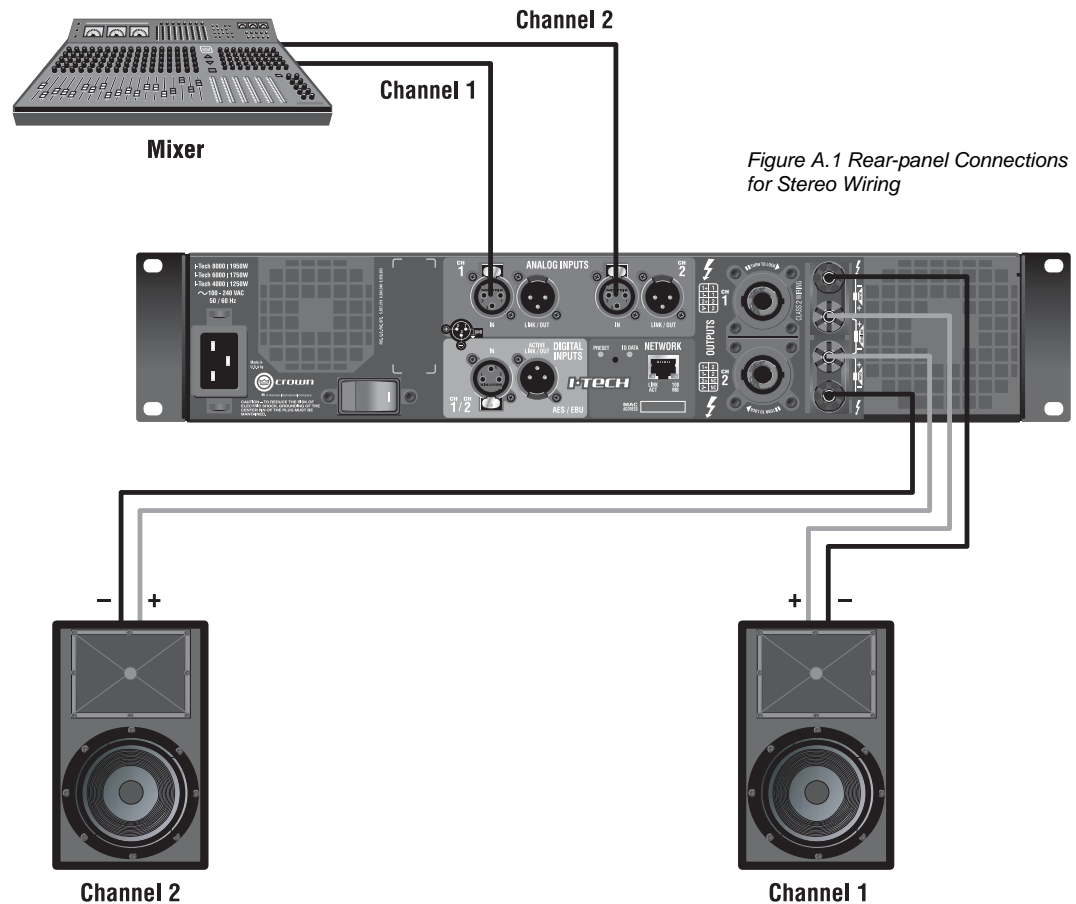

Figure A.1 Rear-panel Connections for Stereo Wiring

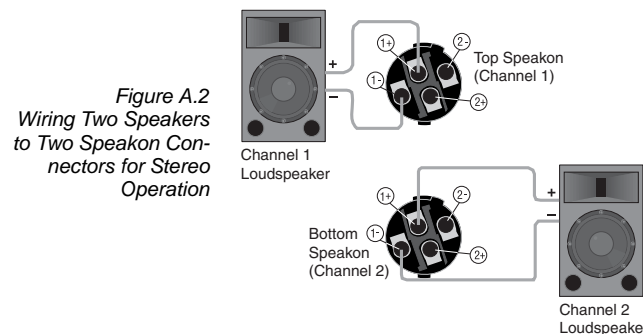

Figure A.2 Wiring Two Speakers to Two Speakon Connectors for Stereo Operation

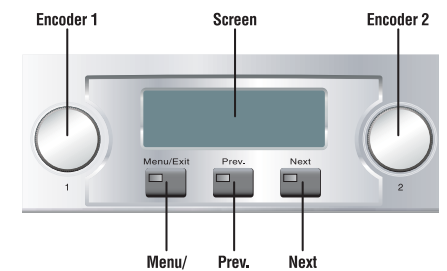

Figure A.3 The LCD Control Screen

Quick-Start Guide: Bridge-Mono Wiring

Let's assume that you unpacked and installed your amplifier with the proper cooling. If not, see Section 2 in this manual. We'll also assume that you will operate the amplifier in Bridge-Mono. Basically you will turn on the amp, enable Bridge-Mono mode with the LCD Control Screen, turn off the amp, wire it, and turn it back on.

1. Be sure that no cables are connected to the amplifier. Plug the amplifier power cord into the amplifier, then into an AC outlet.
2. Turn on the amplifier power switch on the front panel. The LCD Control Screen will light up (Figure A.4).
3. Under the LCD Control Screen, press the **Menu/Exit** button. Press the **Next** button until you see **Output Mode** on the screen.
4. Press either Encoder knob to select BRIDGE MONO. Press and hold the knob to confirm your choice. Press the **Menu/Exit** button.
5. **IMPORTANT: Turn off the amplifier. Unplug its power cord from the AC outlet. The amplifier must be grounded when plugged into AC power.**
6. See Figure A.5. Connect a cable from your mixer output to the amplifier's Channel-1 XLR input connector.
7. Using Class 2 wiring, connect the speaker cable either to the amplifier's top Speakon connector (terminals 1+ and 2+, Figure A.6) or across the red binding posts of both channels (Figure A.5). Do not use the black binding posts in bridge-mono mode.
8. Turn down your mixer master faders. Plug the power cord into the amplifier and then into an AC outlet. Turn on the front-panel power switch. The LCD Control Screen will light up (Figure A.3).

9. Using both Encoder knobs (Level controls), set Attenuation to 0 dB. Press the **Menu/Exit** button, then the **Next** button, to access CH1 Sensitivity. Turn an Encoder knob fully down (CCW) until the minimum dB gain is displayed. See Appendix B for details.

10. Play a program through your mixer. Set its level to peak at 0 dB or 0 VU maximum on the mixer meters. Gradually turn up (CW) the left Encoder knob (Level control) to the desired volume for CH1. Press **Exit** when done.

Note: If the SPL is too high at the beginning of Step 10, press **Menu/Exit**, then press **Next** until you see **ADVANCED MENU**. Push an Encoder knob. Press **Next** until you see **MAXIMUM ANALOG INPUT**. Press an Encoder knob so the display reads 21 dBu. Press **Menu/Exit** twice. Press **Next**. CH1 Sensitivity will be displayed. Gradually turn up (CW) the left Encoder knob to the desired volume for CH1. Press **Exit** when done.

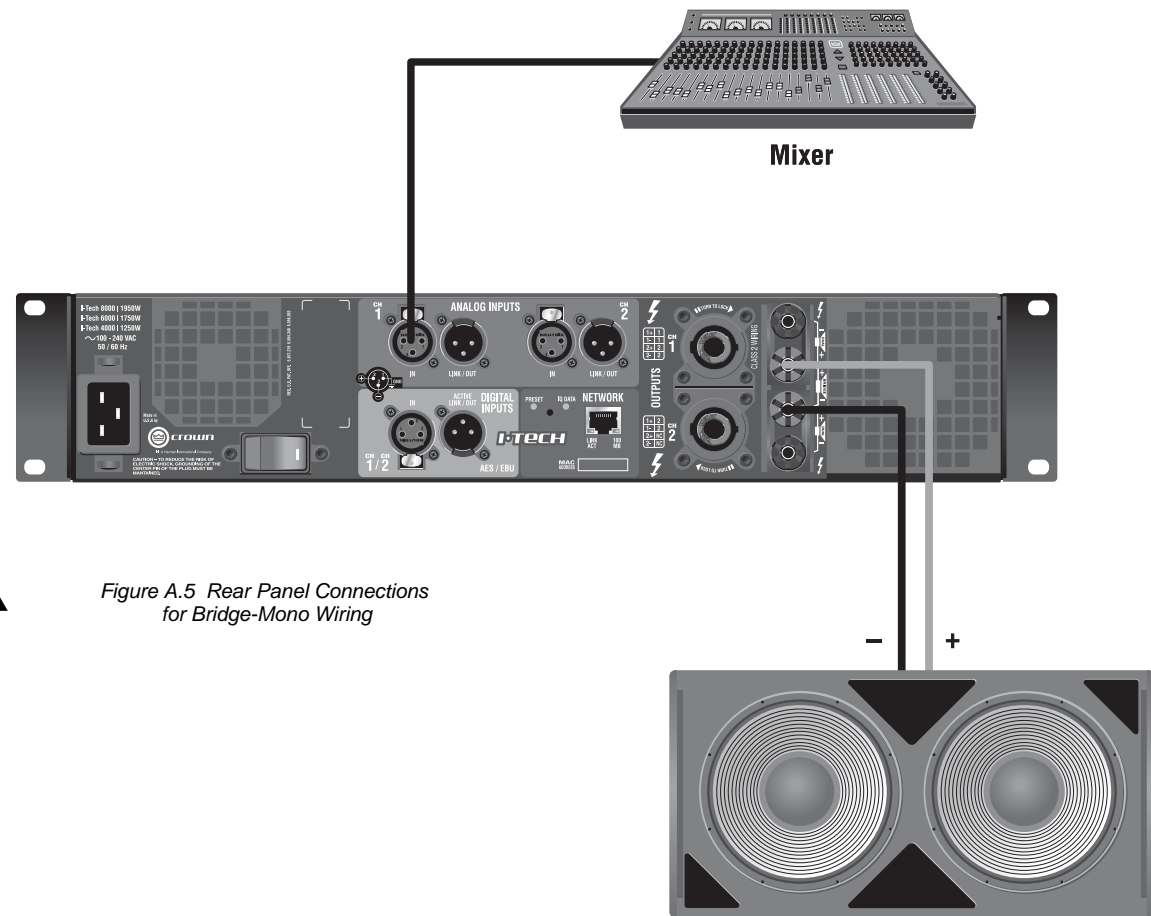

Figure A.5 Rear Panel Connections for Bridge-Mono Wiring



CAUTION – SHOCK HAZARD: Potentially lethal voltages exist at the output connectors when the amplifier is turned on and is passing a signal.

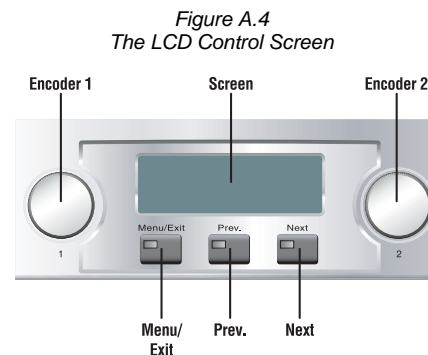

Figure A.4 The LCD Control Screen

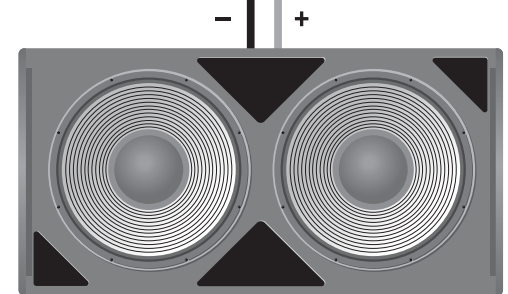

Figure A.6 Wiring a Speaker to the Top Speakon Connector for Bridge-Mono Operation

Table of Contents

Important Safety Instructions	2	4.3 Presets	22
Declaration of Conformity.....	3	4.4 Digital-Audio Options (AES/EBU).....	22
Getting Started with I-Tech	4	4.5 Network Setup Wizard	23
Quick Start Guide: Stereo Wiring.....	4	4.6 Software-Controllable Onboard DSP	24
Quick Start Guide: Bridge-Mono Wiring.....	5	5 Troubleshooting	27
Table of Contents.....	6	6 Specifications	29
1 Welcome	7	6.1 Performance.....	29
1.1 Features	7	6.2 Charts.....	31
1.2 How to Use This Manual	7	7 AC Power Draw and Thermal Dissipation	32
2 Setup	8	8 Advanced Features	35
2.1 Unpack and Install Your Amplifier	8	8.1 Protection Systems	35
2.2 Connecting to AC Mains	9	8.2 Global, Switching Power Supply with PFC	35
2.3 Wire Inputs and Outputs	9	8.3 3rd Generation Class I Circuitry	35
3 Operation	13	8.4. Color-Coded Rear Overlay	35
3.1 Protecting Your Speakers	13	8.5 Rear Rack Ears with Integral EZ-Rack Pin	35
3.2 Startup Procedure	13	9 Appendix A: Network Basics	36
3.3 Precautions	13	Appendix B: Setting Sensitivity for Best Gain Staging....	38
3.4 Front Panel Controls and Indicators	14	10 Service	39
3.5 Back Panel Controls, Indicators and Connectors	15	11 Warranty	40
4 Advanced Operation.....	16	Product Registration.....	43
4.1 Advanced Operation Table of Contents	16	Crown Factory Service Information Form	45
4.2 Navigating the LCD Control Screen.....	17		

I-T4000	20 Hz - 20 kHz Power
2-ohm Dual (per ch.)	1,800W
4-ohm Dual (per ch.)	2,000W
8-ohm Dual (per ch.)	1,250W
4-ohm Bridge	3,600W
8-ohm Bridge	4,000W

20 Hz - 20 kHz Power refers to guaranteed minimum power in watts with 0.35% THD.

I-T6000	20 Hz - 20 kHz Power
2-ohm Dual (per ch.)	2,500W
4-ohm Dual (per ch.)	3,000W
8-ohm Dual (per ch.)	1,500W
4-ohm Bridge	5,000W
8-ohm Bridge	6,000W

20 Hz - 20 kHz Power refers to guaranteed minimum power in watts with 0.35% THD.

I-T8000	20 Hz - 20 kHz Power
2-ohm Dual (per ch.)	3,500W
4-ohm Dual (per ch.)	4,000W
8-ohm Dual (per ch.)	2,100W
4-ohm Bridge	7,000W
8-ohm Bridge	8,000W

20 Hz - 20 kHz Power refers to guaranteed minimum power in watts with 0.35% THD.



1 Welcome

The Crown® I-Tech Series offers amazing power, light weight and ease of use for touring sound applications. Unlike other amplifiers, it includes onboard DSP, an LCD control screen, and a built-in network connection.

Modern power amplifiers are sophisticated pieces of engineering capable of producing extremely high power levels. They must be treated with respect and correctly installed if they are to provide the many years of reliable service for which they were designed.

In addition, I-Tech Series amplifiers include a number of features which require some explanation before they can be used to their maximum advantage.

Please take the time to study this manual so that you can obtain the best possible service from your amplifier.

1.1 Features

- Global Power Supply with PFC (Power Factor Correction) works anywhere in the world.
- High power density, up to 8000 watts in a 2U chassis.
- Highest output voltage in the industry (200V peak) provides clean transient peaks.

- 3rd-generation patented Class I (BCA®) circuitry couples power efficiently to the load and provides low AC current draw.

- Onboard DSP with 24-bit, 96 kHz Cirrus Logic A/D and D/A converters.

- Pushbutton presets simplify setup. Custom presets for various loudspeakers can be down-loaded.

- AES/EBU digital audio input. Ethernet connector accepts RJ-45 connector for HiQnet™ or TCP/IQ networking.

- Analog and digital thru connectors.

- LCD Control Screen is used to adjust the amplifier's attenuation and muting, configure the amp, set up and view error monitoring, and recall DSP presets to reconfigure the amp for various applications.

- Comprehensive array of indicators provide accurate diagnostics: Power, Data, Bridge, along with Ready, Signal, Clip, Thermal and Fault for each channel.

- AC mains indicator in power switch glows green when AC power is present.

- Light weight due to aluminum chassis, special internal construction and switching power supply.

- Thermal management controller and two discrete thermal zones with variable-speed fans, forced-air cooling.

- Advanced protection circuitry guards against: shorted outputs, DC, mismatched loads, general overheating, under/over voltage, high-frequency overloads and internal faults.

- Three-Year, No-Fault, Fully Transferable Warranty completely protects your investment and guarantees its specifications.

1.2 How to Use This Manual

This manual provides you with the necessary information to safely and correctly setup and operate your amplifier. It does not cover every aspect of installation, setup or operation that might occur under every condition. For additional information, please consult Crown's *Amplifier Application Guide* and *I-Tech Application Guide* (available online at www.crownaudio.com), Crown Technical Support, your system installer or retailer.

We strongly recommend you read all instructions, warnings and cautions contained in this manual. Also, for your protection, please send in your warranty registration card today. And save your bill of sale — it's your official proof of purchase.

2 Setup



2.1 Unpack and Install Your Amplifier

Please unpack and inspect your amplifier for any damage that may have occurred during transit. If damage is found, notify the transportation company immediately. Only you can initiate a claim for shipping damage. Crown will be happy to help as needed. Save the shipping carton as evidence of damage for the shipper's inspection.

We also recommend that you save all packing materials so you will have them if you ever need to transport the unit. **Never ship the unit without the factory pack.**

YOU WILL NEED (not supplied):

- Input wiring cables
- Output wiring cables

Rack for mounting amplifier (or a stable surface for stacking)



WARNING: Before you start to set up your amplifier, make sure you read and observe the Important Safety Instructions found at the beginning of this manual.



CAUTION: Before you begin, make sure your amplifier is disconnected from the power source, with the power switch in the "off" position and all level controls turned completely down (counterclockwise).

Use a standard 19-inch (48.3 cm) equipment rack (EIA RS-310B). See Figure 2.1 for amplifier dimensions.

You may also stack amps without using a cabinet.

NOTE: When transporting, amplifiers should be supported at both front and back.

MAGNETIC FIELD



CAUTION! Do not locate sensitive high-gain equipment such as preamplifiers or tape decks directly above or below the unit. Because this amplifier has a high power density, it has a strong magnetic field which can induce hum into unshielded devices that are located nearby. The field is strongest on the right side and right bottom of the amplifier (facing the amplifier).

If an equipment rack is used, we recommend locating sensitive equipment at least 20 cm (8 inches) away from the amplifier.

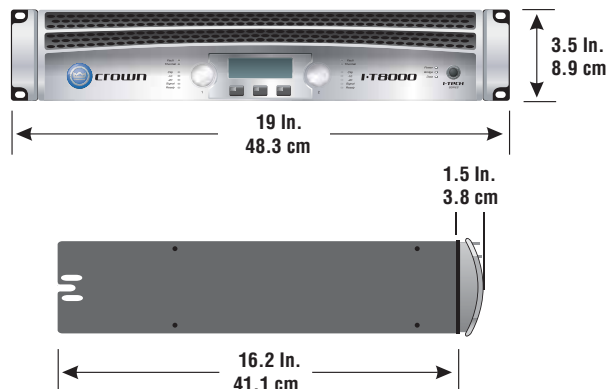

Figure 2.1
Dimensions

When using an equipment rack, mount units directly on top of each other. Close any open spaces in rack with blank panels. DO NOT block front or rear air vents. The side walls of the rack should be a minimum of two inches (5.1 cm) away from the amplifier sides, and the back of the rack should be a minimum of four inches (10.2 cm) from the amplifier back panel.

Figure 2.2 illustrates standard amplifier airflow.

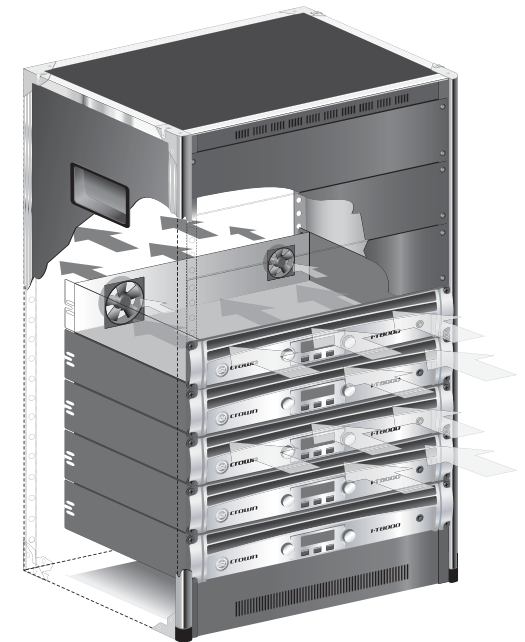

Figure 2.2 Airflow

2 Setup

2.2 Connecting to AC Mains

WARNING: The third (ground) prong of the supplied AC power cord connector is a required safety feature. Do not attempt to disable this ground connection by using an adapter or other methods.



Amplifiers don't create energy. The AC mains voltage and current must be sufficient to deliver the power you expect. You must operate your amplifier from an AC mains power source with not more than a 10% variation above or a 15% variation below the amplifier's specified line voltage range and within the specified frequency requirements (indicated on the amplifier's back panel label). If you are unsure of the output voltage of your AC mains, please consult your electrician.

Packed with your I-Tech amplifier is a clip that retains the power cord so it can't pull out accidentally.

1. Locate the clip in a bag in the I-Tech packing carton.
2. Locate the IEC power connector on the back of the amplifier. Above and below that connector are two slots. Stretch the ends of the clip and insert them into the slots (Figure 2.3).
3. Plug the power cord all the way into the amplifier IEC power connector.
4. Pull the clip to the left and snap it onto the power cord.

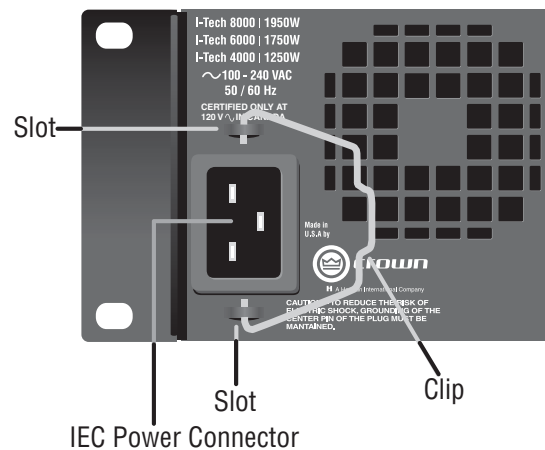

Figure 2.3 IEC Power Connector Clip

2.3 Wire Inputs and Outputs

2.3.1 Wiring basics

- Always use shielded wire for input wiring. The higher the density of the shield (the outer conductor) the better. Spiral wrapped shield is not recommended.
- When using unbalanced lines keep the cables as short as possible. Avoid lengths greater than 10 feet (3 meters).
- Do not run the audio input cables together with the high-level wiring such as loudspeaker wires or AC cords. (This lessens the chance of hum and noise being induced into the input cables.)
- Turn the entire sound system off before changing any connections. Crown is not liable for damage incurred when any transducer or component is overdriven.



THE CHANNEL 2 INPUT IS IGNORED if the amplifier is used in Bridge-Mono mode.

For additional information on audio input wiring please refer to the *Crown Amplifier Application Guide* available online at www.crownaudio.com. It contains helpful information on preventing unwanted subsonic frequencies, radio frequency interference, ground loops, and feedback oscillation.

2 Setup

2.3.2 Choose Input Wire and Connectors

Crown recommends using pre-built or professionally wired, balanced line (two-conductor plus shield), 22-24 gauge cables and connectors. Use 3-pin male XLR connectors.

Unbalanced line may also be used but may result in noise over long cable runs.

Figure 2.4 shows connector pin assignments for balanced analog wiring or AES/EBU digital wiring. The use of standard analog cable with AES/EBU will result in diminished performance. For best results, 110 ohm shielded twisted-pair cable for AES/EBU signals is highly recommended. Figure 2.5 shows connector pin assignments for unbalanced analog wiring.

NOTE: Custom wiring should only be performed by qualified personnel.

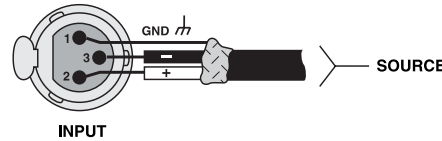

Figure 2.4
Balanced Analog Input Connector Wiring or
AES/EBU Digital Connector Wiring

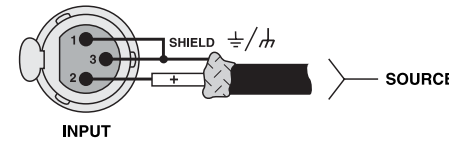

Figure 2.5 Unbalanced Analog Input Connector Wiring

2.3.3 Choose Output Wire and Connectors

Crown recommends using pre-built or professionally wired, high-quality, two- or four-conductor, heavy gauge speaker wire and connectors. Use Class 2 output wiring. You may use a 4-pole Speakon connector (Figure 2.6) or banana plugs, spade lugs, or bare wire for your output connectors (Figure 2.7). To prevent the possibility of short circuits, wrap or otherwise insulate exposed loudspeaker cable connectors.

CAUTION – SHOCK HAZARD: Potentially lethal voltages exist at the output connectors when the amplifier is turned on and is passing a signal.



Using the guidelines below, select the appropriate size of wire based on the distance from amplifier to speaker.

Distance	Wire Size
up to 25 ft.	16 AWG
26-40 ft.	14 AWG
41-60 ft.	12 AWG
61-100 ft.	10 AWG
101-150 ft.	8 AWG
151-250 ft.	6 AWG

CAUTION: Never use shielded cable for output wiring.



Figure 2.6
Left: Speakon Output Connector on Back Panel
Right: Speakon Cable Connector

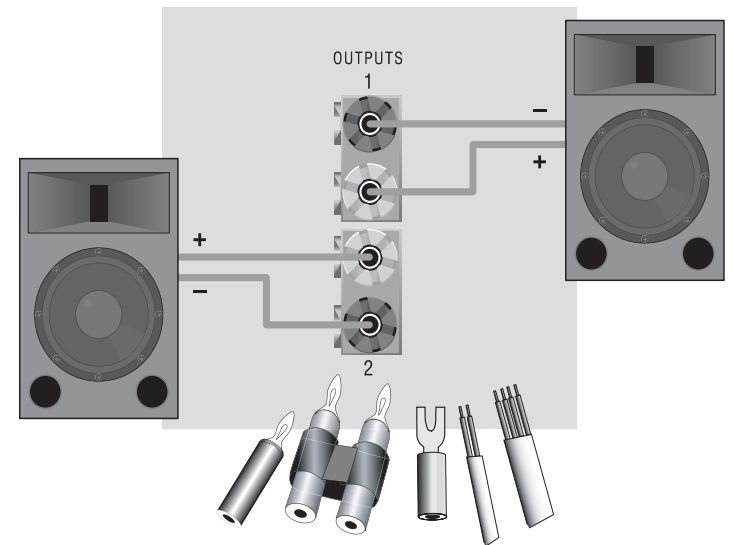

Figure 2.7
Binding Post Connections

2 Setup

2.3.4 Stereo Mode Wiring

Typical input and output wiring is shown in Figure 2.8.

IMPORTANT: Turn off the amplifier and unplug its power cord.



INPUTS: Choose one of these options:

- Connect analog input wiring for both channels.
- Connect an AES/EBU digital signal to the AES/EBU connector.

OUTPUTS: Maintain proper polarity (+/-) on output connectors. Use Class 2 output wiring.

Figure 2.8 shows how to wire stereo speakers to the binding posts. Connect Channel 1 loudspeaker's positive (+) lead to Channel 1 positive (red) terminal of amp; repeat for negative (-). Repeat Channel 2 wiring as for Channel 1.

To wire stereo speakers to the Speakon connectors, use one of these methods:

Method 1 (Table 1 and Figure 2.9): Wire one Speakon cable connector to two speakers. Insert the Speakon cable connector into the amplifier's top Speakon connector.

Method 2 (Table 2 and Figure 2.10): Plug the Channel 1 speaker into the Channel 1 (top) Speakon connector, and plug the Channel 2 speaker into the Channel 2 (bottom) Speakon connector.

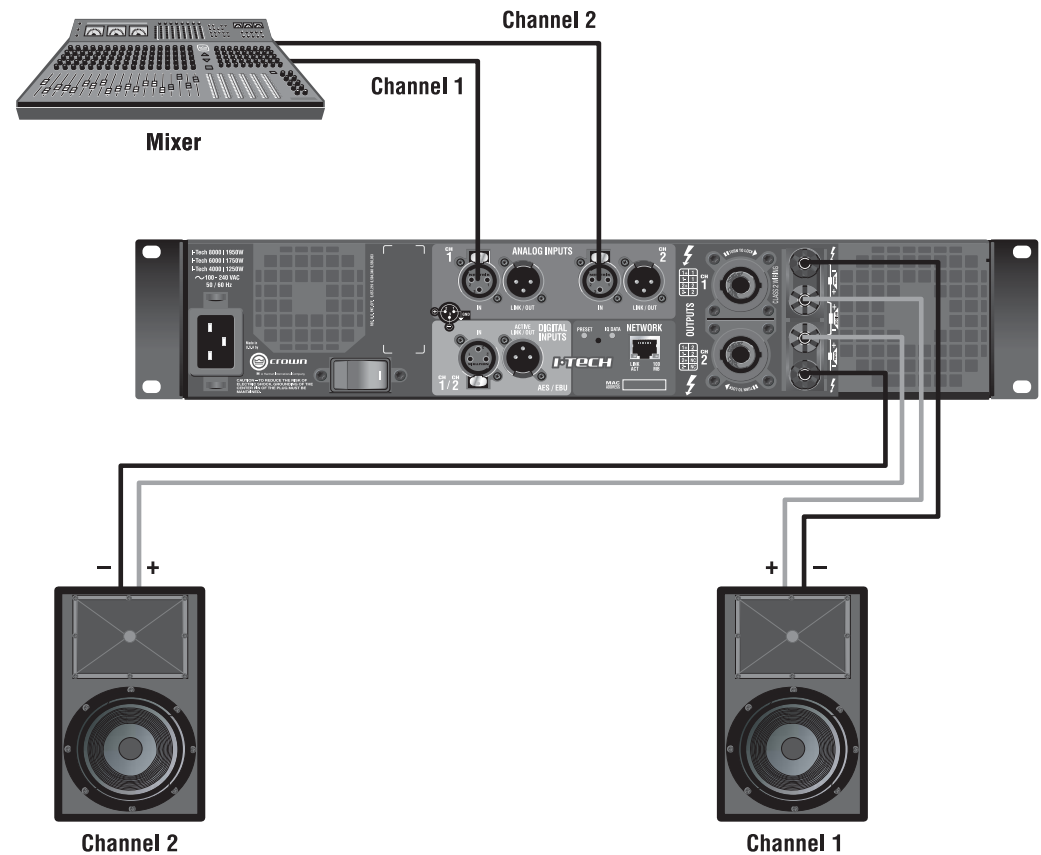

Figure 2.8
System Wiring,
Stereo Mode

Table 1

Stereo Wiring Method 1: Use Top Speakon Only

PIN	1+	1-	2+	2-
CH	1+	1-	2+	2-

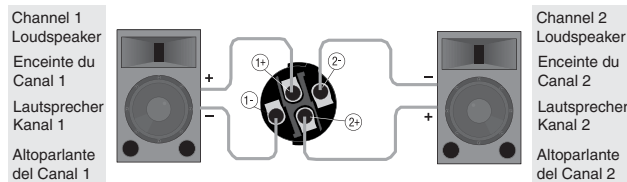

Figure 2.9 Wiring Two Stereo Speakers
to the Top Speakon Connector

Table 2

Stereo Wiring Method 2: Use Both Speakons

Top Speakon	PIN	1+	1-
	CH	1+	1-
Bottom Speakon	PIN	1+	1-
	CH	2+	2-

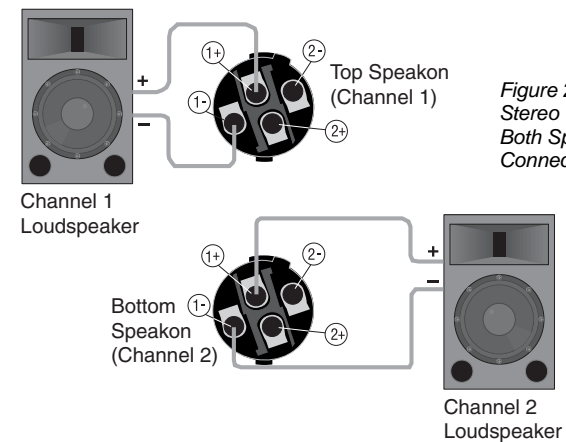

Figure 2.10
Stereo Wiring Using
Both Speakon
Connectors

2 Setup

2.3.5 Bridge-Mono Mode

Overview: Turn on the amp, enable Bridge-Mono mode using the LCD Control Screen, turn off the amp, wire it, and turn it back on.

1. Be sure that no cables are connected to the amplifier. Turn on the front-panel power switch. The LCD Control Screen will light up (Figure 2.11).

2. Under the LCD Control Screen, press the **Menu/Exit** button. Press the **Next** button until you see OUTPUT MODE on the screen.

3. Press an Encoder knob to select BRIDGE MONO. Press the knob again to confirm your choice. Press **Menu/Exit**. Turn down both level controls (Encoders) until you reach maximum attenuation.

4. IMPORTANT: Turn off the amplifier and unplug its power cord. 

INPUTS: There are three ways to connect an input signal to the amplifier (Figure 2.12):

- Connect an analog signal source to the Channel-1 amplifier input.
- Connect an AES/EBU digital signal source to the Digital Input IN connector.

NOTE: Crown provides a reference of wiring pin assignments for commonly used connector types in the *Crown Amplifier Application Guide* available at www.crownaudio.com.

OUTPUTS: Use Class 2 output wiring. There are two ways to wire the amplifier output connectors for Bridge-Mono mode:

- 1) Wire the speaker across the red binding post of each channel (Figure 2.12). Do not use the black binding posts when operating in Bridge-Mono mode.
- 2) Wire the speaker only to the top Speakon connector as shown in Table 3 and Figure 2.13.

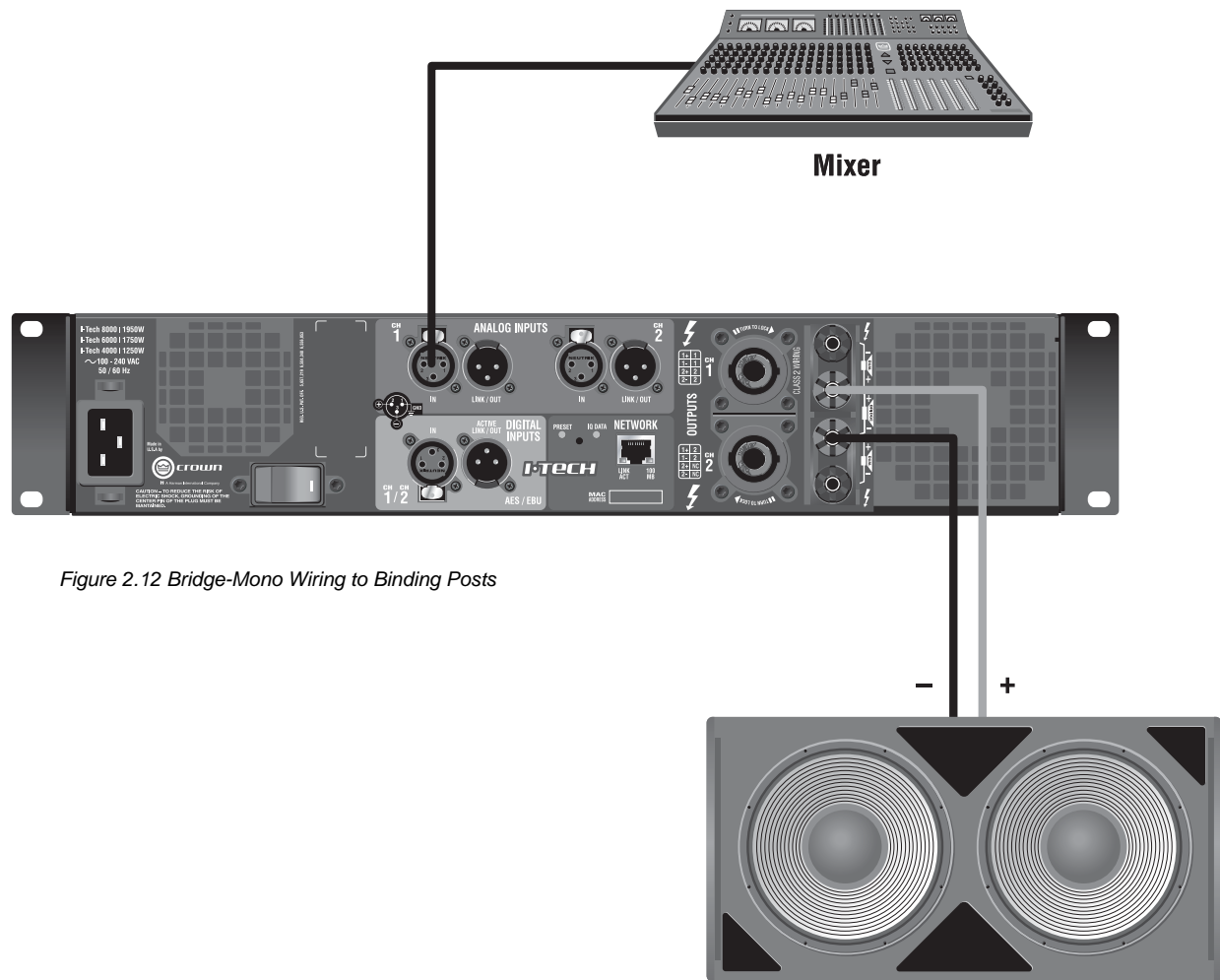

Figure 2.12 Bridge-Mono Wiring to Binding Posts

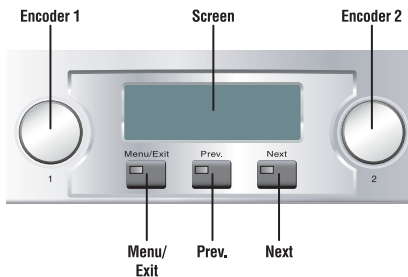

Figure 2.11
The LCD Control Screen

NOTE: In Bridge-Mono mode, the Channel 1 Level control sets the level; the Channel 2 Level control is defeated.

Table 3

Top Speakon Wiring for Bridge-Mono

PIN	1+	2+
SPKR	+	-

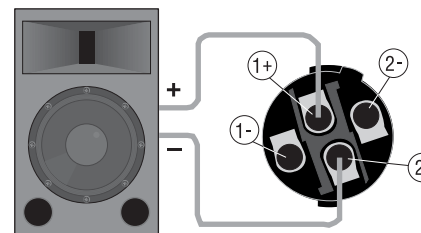

Figure 2.13
Wiring a Speaker in Bridge-Mono Mode to the Top Speakon Connector

3 Operation

3.1 Protecting Your Speakers

It's wise to avoid clipping the amplifier signal. Not only does clipping sound bad, it can damage high-frequency drivers. To prevent clipping, use IQwic™ or System Architect software to enable or display the peak voltage limiter and average power limiter in your amplifier's built-in DSP. That way, no matter how strong a signal your mixer produces, the amplifier output will not clip. Set the limiter threshold so that mixer signals above 0 dB or 0 VU on the mixer meters do not quite drive the amplifier into clipping.

Also, avoid sending strong subsonic signals to the amplifier. High-level, low-frequency signals from breath pops or dropped microphones can blow out drivers. To prevent subsonic signals, use one of these methods:

- Insert a highpass filter between mixer output and amplifier input (or between mixer and limiter).
- Use the I-Tech's onboard DSP to set up a highpass filters.
- Switch in highpass filters at your mixer. Set the filter to as high a frequency as possible that does not affect your program. For example, try 35 Hz for music and 75 Hz for speech. On each mixer input channel, set the filter frequency just below the lowest fundamental frequency of that channel's instrument.

3.2 Startup Procedure

When first turning on your amplifier, follow the procedures in the Quick-Start Guide on page 4 (stereo) or page 5 (bridge-mono).

If you ever need to make any wiring or installation changes, don't forget to disconnect the power cord.

For help with determining your system's optimum gain structure (signal levels) please refer to the Crown *Amplifier Application Guide*, available online at www.crownaudio.com.

3.3 Precautions

Your amplifier is protected from internal and external faults, but you should still take the following precautions for optimum performance and safety:

1. Before use, your amplifier first must be configured for proper operation, including input and output wiring hookup. Improper wiring can result in serious operating difficulties. For information on wiring and configuration, please consult the Setup section of this manual or, for advanced setup techniques, consult Crown's *Amplifier Application Guide* available online at www.crownaudio.com.

2. Use care when making connections, selecting signal sources and controlling the output level. The load you save may be your own!
3. Do not short the ground lead of an output cable to the input signal ground. This may form a ground loop and cause oscillations.



4. **WARNING: Never connect the output to a power supply, battery or power main. Electrical shock may result.**

5. Tampering with the circuitry, or making unauthorized circuit changes may be hazardous and invalidates all agency listings.
6. Do not operate the amplifier with the red Clip LEDs constantly flashing.
7. Do not overdrive the mixer, which will cause clipped signal to be sent to the amplifier. Such signals will be reproduced with extreme accuracy, and loudspeaker damage may result.
8. Do not operate the amplifier with less than the rated load impedance. Due to the amplifier's output protection, such a configuration may result in premature clipping and speaker damage.



9. **CAUTION – SHOCK HAZARD: Potentially lethal voltages exist at the output connectors when the amplifier is turned on and is passing a signal.**

Remember: Crown is not liable for damage that results from overdriving other system components.

3 Operation

3.4 Front Panel Controls and Indicators

A. Cooling Vents

Front-to-rear forced airflow through foam dust filter.

LCD Control Screen and Controls

B. LCD Control Screen

Integrated LCD with white backlight, controls amplifier setup and operation.

The LCD Control Screen and its controls let the user adjust the amplifier's attenuation and muting, configure the amp, set up and view error monitoring (such as temperature and load supervision), and recall DSP presets. The presets allow the user to quickly reconfigure the amp for various applications.

C. Level Controls (Encoders)

Speed-sensitive, 0.5 dB steps, range 0 to -100 dB. These two knobs affect the Channel-1 and Channel-2 output levels. They also select Menu items and adjust parameter values that are displayed on the LCD control screen.

D. Menu/Exit Button

"Menu" enters the main menu. "Exit" leaves the menu.

E. Prev Button

Selects the previous item in the menu.

F. Next Button

Selects the next item in the menu.

Thermal and Fault Indicators

G. Clip Indicator

Red LED, one per channel, illuminates when the channel's output signal reaches the onset of audible

clipping. The Clip Indicator also will illuminate during Thermal Level Control (TLC) limiting.

H. Thermal Indicator

Red LED, one per channel, illuminates when the channel has shut down due to thermal stress or overload.

I. Fault Indicator

Red LED, one per channel, flashes when the amplifier output channel has stopped operating. Usually this means that the amplifier must be serviced.

Signal Indicators

Three green LEDs per channel indicate the amplifier's input and output signal levels. From top to bottom the LEDs are:

J. -10 dB: amplifier output is 10 dB below clipping.

K. -20 dB: amplifier output is 20 dB below clipping.

L. Signal: input signal is above -40 dBu.

M. Ready Indicator

Green LED, one per channel, illuminates when the channel is initialized and ready to produce audio output. Indicator is off when the channel is set to standby mode via System Architect or the IQ system.

N. Power Indicator

Blue LED indicates amplifier has been turned on and AC power is available. The LED will flash when the AC line voltage is 15% above or below the nominal rated range.

O. Bridge Mode Indicator

Yellow LED illuminates when the amplifier is set to Bridge-Mono mode.

P. Data Indicator

Yellow LED indicates HiQnet or IQ data activity. Data indicator flashes only when the amplifier is polled for data, or is polled to see whether it is online.

Q. Power Switch

Push-on/push-off switch glows green when AC power is present at the power cord and the amplifier circuit breaker is in the "on" position.

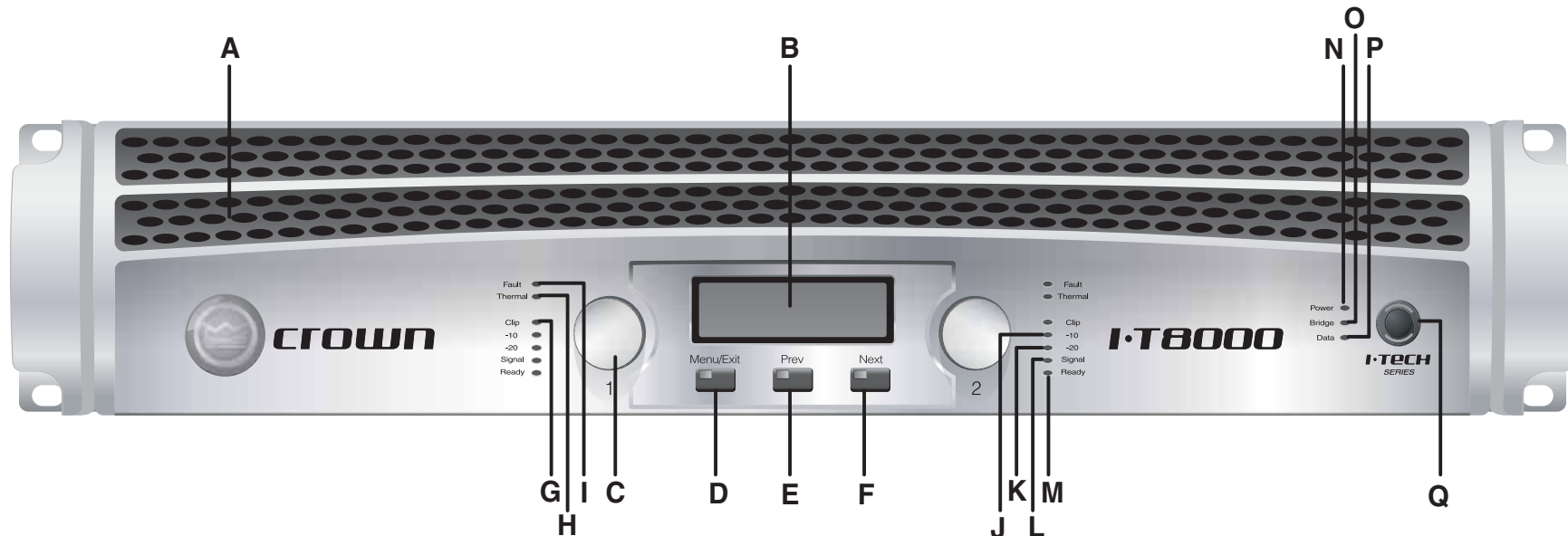

Figure 3.1 Front Panel Controls and Indicators

3 Operation

3.5 Back Panel Controls, Indicators and Connectors

A. Fans

Provide front-to-back forced airflow for cooling.

ANALOG INPUTS SECTION

B. Balanced Analog XLR Inputs

A 3-pin female XLR connector for each channel.

C. Balanced Analog XLR Loop-Through Outputs

Two 3-pin male XLR output connectors are provided (one per channel). The signal at these connectors is paralleled with the input signal for feeding the input signal to other amplifiers.

OUTPUTS SECTION

D. 4-Pole Speakon Output Connectors

Two high-current, 50A Neutrik® Speakon NL4MLP (mates with NL4FC and NL4), one per channel. Class 2 output wiring required.

These two connectors accept 2-pole or 4-pole Speakon connectors. See Figures 2.5 through 2.10 and Tables 1, 2 and 3 for connector wiring. The top Speakon connector is wired for both channels so it can be used for bridge-mono wiring or for stereo wiring of two speakers to a single Speakon connector.

E. Binding Post Output Jacks

One pair per channel of high-current, 60A color-coded binding posts. Accepts banana plugs, wire or spade lugs.

F. Power Cord Connector

Standard 20 amp IEC inlet. Voltage range is indicated above IEC inlet.

G. Reset Switch/Circuit Breaker

If the current draw of the amplifier exceeds safe limits, this breaker automatically disconnects the power supply from the AC mains. The switch resets the circuit breaker.

DIGITAL INPUTS SECTION

H. AES/EBU Digital Input

This 3-pin female XLR connector accepts a digital signal in the AES/EBU format.

I. AES/EBU Digital Loop-through Output

Male XLR active/re-clocked AES/EBU digital loop-through. The signal at this connector duplicates the digital input signal for feeding the input signal to other amplifiers.

It is not recommended to loop through more than four amplifiers. If larger distribution of AES is needed, the use of an AES distribution amplifier is recommended.

NETWORKING SECTION

J. Preset Indicator

Yellow LED flashes to signal the number of the current preset if active.

K. Data Indicator

Yellow LED indicates HiQnet or IQ data activity. Data indicator flashes only when the amplifier is polled for data, or is polled to see whether it is online.

L. Network Connector

This Ethernet connector accepts an RJ-45 connector for networking. Built into the connector is a yellow LINK ACT indicator that shows network activity, and a green 100Mb indicator that shows a 100Mb network connection.

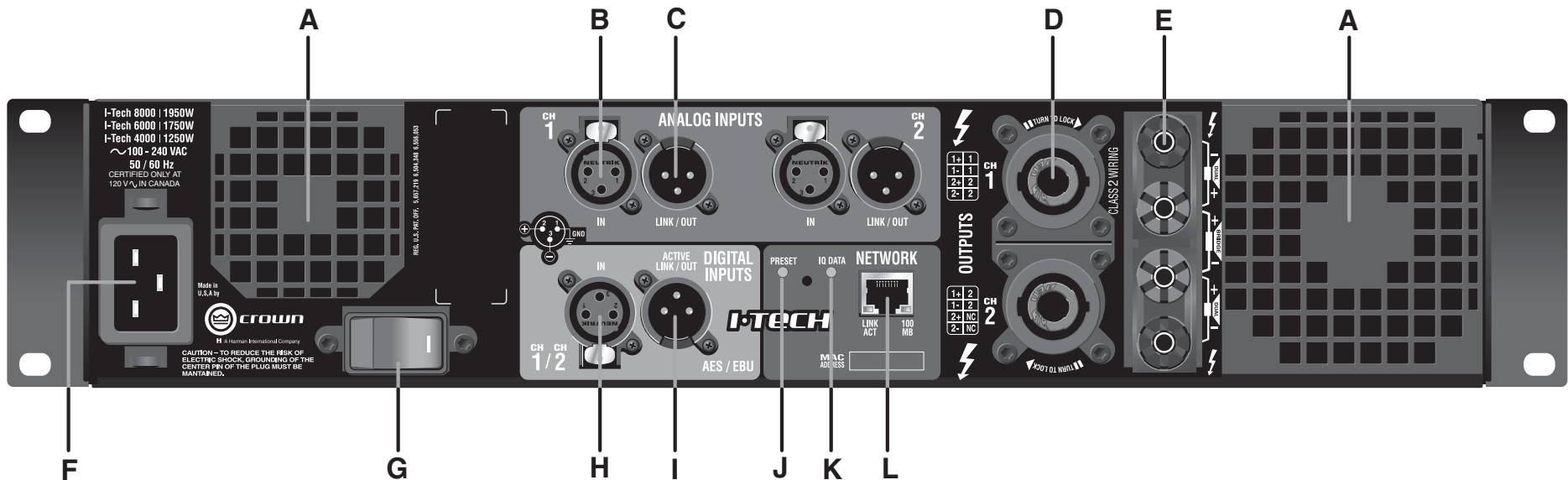

Figure 3.2 Back Panel Controls and Connectors

4 Advanced Operation

4.1 Advanced Operation Table of Contents.....	16
4.2 Navigating the LCD Control Screen	17
4.2.1 Introduction.....	17
4.2.2 Basic Menu.....	17
4.2.3 Advanced Menu.....	18
4.2.4 Monitor Menu	19
4.2.5 Operation Examples.....	21
4.2.6 Menu Tree.....	21
4.3 Presets	22
4.3.1 Introduction	22
4.3.2 User Presets	22
4.3.3 Downloadable Presets	22
4.4 Digital Audio Options (AES/EBU).....	22
4.5 Network Setup Wizard	23
4.6 IQ-Controllable Onboard DSP	24
4.6.1 User Presets	24
4.6.2 Clip Event Monitor	24
4.6.3 Input Signal Level Monitor	24
4.6.4 Output Signal Level Monitor	24
4.6.5 Thermal Headroom Level Monitor	24
4.6.6 Power/Standby Control	24
4.6.7 Signal Mute	24
4.6.8 Polarity Inverter	24
4.6.9 Dynamic Gain Monitors (Ghost Faders)	24
4.6.10 Amplifier Information	24
4.6.11 User and Channel Labels	24
4.6.12 Line Voltage Monitor	24
4.6.13 Error Reporting	24
4.6.14 Input Signal Compressor/Limiter	25
4.6.15 Peak Voltage Limiter	25
4.6.16 Average Power Limiter	25
4.6.17 Clip Eliminator	25
4.6.18 Limiter Tie	25
4.6.19 Load Supervision	25
4.6.20 Memory Backup Configuration	25
4.6.21 Input Signal Router	26
4.6.22 Filters	26
4.6.23 Delay (Latency).....	26
4.6.24 Noise Generator	26
4.6.25 Sine-wave Generator	26

4 Advanced Operation

4.2 Navigating the LCD Control Screen

4.2.1 Introduction

The LCD Control Screen and its controls let you configure the amplifier and access many features that before were available only through a remote computer. Also, you can recall DSP presets for certain loud-speaker models. (Some DSP parameters cannot be adjusted with the LCD Control Screen. That is done in System Architect or IQwic.)

Figure 4.1 shows the parts of the LCD Control Screen. Its functions are described below. NOTE: Listed functions can also be controlled in System Architect or IQwic. The LCD-screen Menu Tree is on Page 21.

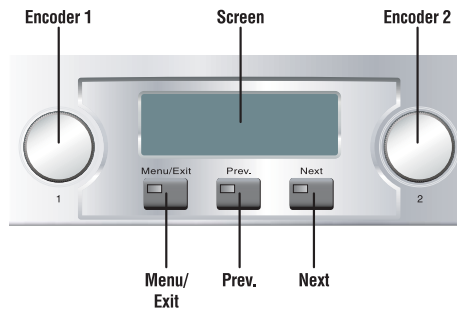
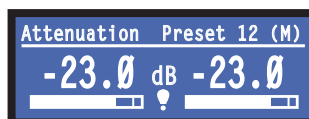

Figure 4.1 Parts of the LCD Control Screen

Attenuation and Bar Meters

On power-up with the factory defaults, the LCD Control Screen displays the attenuation in dB and on bar meters. To change the attenuation in either channel, turn the **Encoder**. Attenuation changes 0.5 dB per detent when you turn the Encoder slowly, and more when you turn the Encoder quickly. The current preset name is displayed in the upper-right corner. The (M) is explained on page 18 under Presets.

If Attenuator Limits have been set (in the Attenuator Limits screen, described later), small lines showing those limits will appear in the bar meters as shown. If the attenuators for both channels are linked (in the Attenuator Link screen, described later), the word LINK appears. If there is an error in the error log, an exclamation point appears at bottom center.



Mute/Unmute

- To mute either channel: Press and hold an Encoder knob for 1 second. The display will alternate between MUTE and the attenuation level. While the amplifier is muted, you can adjust attenuation for each channel by turning an Encoder knob.
- To unmute either channel: Press and hold an Encoder knob again for 1 second.

The (M) is explained on page 18 under Presets.

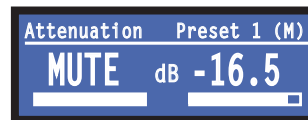

Front Panel Lockout

The amplifier's administrator can control access to menu mode and the amplifier's attenuators. This lockout can be done either by the front panel buttons or by System Architect or IQ software.

To lock or unlock the menu with the front-panel buttons: press **Next** and **Prev** simultaneously. To lock or unlock the menu with System Architect or IQ software: in the IQwic Control Panel, go to the General Page and press the lockout button.

If the lockout is done from the software, the user can disable the lockout only in the software, not by pressing the front-panel buttons.

If the menu is locked and you press any button or turn an Encoder, the word "LOCKED" is displayed.

4.2.2 BASIC MENU

Getting around in the Menu is intuitive. Here are the basic operations:

- Press **Menu/Exit** to enter the main menu.
- Press **Next** to go to the next item in the menu.
- Press **Prev** to go to the previous item in the menu.
- Turn or press either **Encoder** knob to change the value of the displayed parameter.
- Press **Menu/Exit** to leave the menu and return to the Attenuation screen at any time.

Some menu items require confirmation: after you request a change, the display might say "Press and hold." To confirm a change, press and hold an **Encoder** knob. If you don't want the change to occur during a confirmation, turn the knob or wait five seconds.

Basic Menu Items

Contrast: Press **Menu/Exit** to enter the Basic Menu. The first item on the menu you see is the Contrast screen. Turn an Encoder knob to change the contrast of the LCD screen. You can return to the Attenuation screen by pressing **Menu/Exit**, or go to other menu items by pressing **Next** or **Prev**.

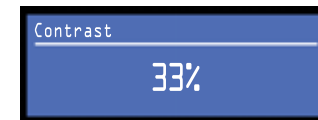

CH1 Sensitivity: Sets the input sensitivity of Channel 1. Turn an Encoder knob to change the input sensitivity.

Note: If you do not see the sensitivity you need, try changing the Maximum Analog Input level in the Advanced Features Menu (described later). This makes different sensitivities available.

To optimize the system gain structure, see Section 3.1 in the I-Tech application Guide at www.crownaudio.com/itech/pdf/137327.pdf.

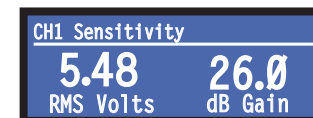

CH2 Sensitivity: Sets the input sensitivity of Channel 2. Turn an Encoder knob to change the input sensitivity. (This screen will not display in Bridge Mono mode).

Note: If you do not see the sensitivity you need, try changing the Maximum Analog Input level in the Advanced Features Menu (described later). This makes different sensitivities available.

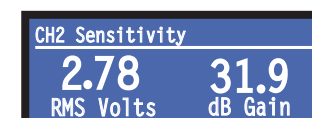

4 Advanced Operation

Presets: A preset is a group of DSP and amplifier settings for a particular speaker. Turn an Encoder to view Presets 1 through 20. To recall a preset, press the Encoder, then press and hold the Encoder to confirm. For more information on presets, see Section 4.3.

The preset currently in use is displayed in the upper right corner.

(A) Active means that the amplifier is operating exactly according to that preset.

(M) Modified means that the amplifier is operating according to the preset but with some settings changed.

If a preset number is flashing, it is not in use.

In the example shown below,

- Preset 7 is in use (it's in the upper right corner).
- The amplifier settings have been modified (M) since Preset 7 was loaded.
- The large "7" is not flashing, which means that Preset 7 is in use.
- Preset 7's Channel-1 label is "MF-1&2".
- Preset 7's Channel-2 label is "MF-3&4".



In the example shown below, you turned down an Encoder knob two notches after loading Preset 7.

- Preset 7 is in use (it's in the upper right corner).
- Preset 7 is active (A). That means the amplifier is operating exactly according to that preset.
- The large "5" is flashing because Preset 5 is not in use.
- Preset 5's Channel-1 label is "LF-1&2".
- Preset 5's Channel-2 label is "LF-3&4".

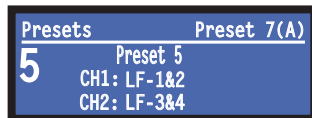

To download presets for a particular loudspeaker unit, visit http://www.crownaudio.com/amp_htm/itech-download.htm or the loudspeaker manufacturer's website.

Output Mode: Press an Encoder knob to select DUAL or BRIDGE (Bridge Mono). You will be prompted to confirm your choice. Press and hold an Encoder knob to confirm your choice. DUAL is the default. The Bridge indicator on the front panel will illuminate when the amplifier is bridged.



Input Y: Press an Encoder knob to select STEREO or Input Y. You will be prompted to confirm your choice. Press and hold an Encoder knob to confirm your choice. When INPUT Y is enabled, Channel 1's input signal feeds both channels. STEREO is the default. (This screen will not display in Bridge Mono mode).

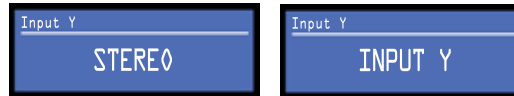

Me/You Amp Finder: Allows users to identify a specific amplifier in a large network of amplifiers without having to compare address information. Me/you can be turned on/off from software and/or the front panel. Press an Encoder knob to turn on the Me/you amp finder. When on, the menu-button LEDs flash (depending on the firmware).



4.2.3 ADVANCED MENU

When you see this screen, press an Encoder knob to enter the Advanced Menu, described next. You can go to the Advanced Menu screen from the Attenuation screen by pressing

Menu/Exit > Prev > Prev.



Attenuator Limits: You can set the minimum attenuation from 0 dB to -100 dB. This feature allows you to set a limit on the attenuators. Once set, attenuation cannot be adjusted above this level. The attenuator limit appears as a line in the attenuator bar meter.

NOTE: The attenuator setting must be below the attenuator limit that you are trying to set. For example, if the attenuator is set at -3 dB, you cannot set the attenuator limit below -3 dB unless you also decrease the attenuator level.



Attenuator Link: Allows either attenuator (Encoder) to control both channels. Push an Encoder knob to select Independent or Linked. Once the attenuators are linked, any difference in channel attenuation will be maintained, and the word LINK appears on the Attenuation screen.



LED Meter Display Type: Press either encoder to make the front-panel output LEDs display average or peak values. This menu changes the operation of the -10 and -20 output LEDs only.



Bar Meter Display Type: You can select what the bar meters will display in the Attenuator Screen. Press an Encoder knob to select Attenuation, Input Levels, Output Levels, or Thermal %.

Attenuation is displayed as the length of the bar meters in the Attenuation screen that appears on startup. Input Levels and Output Levels are displayed as both average and peak in the bar meters.

Thermal % indicates the amplifier temperature in percent, where 100% is the maximum allowable temperature. If Thermal % reaches 100%, the amplifier is out of thermal headroom and has shut down.



Clip Limiter: Limits the output signal to prevent excessive clipping. Press an Encoder knob to select ON or OFF for each channel. OFF is the default.



4 Advanced Operation

Peak Voltage Limiter: Limits the peak output voltage to a level that you set, either OFF or 0 to 255 volts. Press the Encoder to turn on the Limiter. Once it's on, turn the Encoder to set the voltage. Additional controls, such as attack and release, are available through IQwic or System Architect.



Average Power Limiter: Limits the output power to an amount that you set, from 10 watts to the maximum output power of the amplifier. Press the Encoder to turn on the Limiter. Once it's on, turn the Encoder to set the power. Additional controls, such as nominal impedance, attack, and release, are available through IQwic or System Architect.

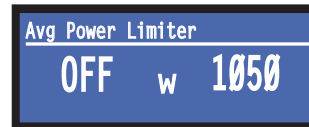

Pink Noise Generator: The default setting is OFF. Press an Encoder knob to turn on the generator. Its level will read -100 dB. Adjust the noise level from -100 dB to +20 dB in 0.5 dB steps by turning Encoder 1 or 2. The level can be adjusted only when this menu option is visible. To turn off the generator, press an Encoder knob or go to another menu item.

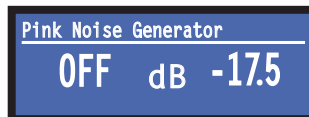

AES/EBU Input Trim: Sets the gain of the AES/EBU digital input signal. Turn an Encoder to change the gain.



Input Source: For each channel, press the Encoder to select analog, digital, or automatic backup source. Options are:
 Digital (DIG)
 Analog (ANLG)
 Digital with analog backup (A ← D)
 Digital with analog override (D ← A)

Digital with analog backup: The I-Tech is being fed a digital signal and an analog signal. The input is currently switched to the digital signal. If it fails, the I-Tech switches instantly to the analog signal.

Digital with analog override: The input is switched to the digital signal, and no analog signal is applied. If an analog signal is sent, the I-Tech switches instantly to the analog signal. If the analog signal fails, the I-Tech switches to the digital signal after a delay set by the Hold Time slider in the Input Section of the IQwic Signal Path Page.



Maximum Analog Input: Press an Encoder to select +21 dBu or +15 dBu. When set to +21 dBu, the maximum input level to the amplifier is +21 dBu. When set to +15 dBu, the maximum input level to the amplifier is +15 dBu. Note: Changing this value changes the range of sensitivities available to the amplifier.

For more information see the I-Tech Sensitivity Charts in the Appendix of the I-Tech Application Guide. It is available online at www.crownaudio.com/itech/pdf/137327.pdf.

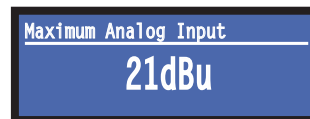

Exit: To exit the Advanced Menu and go to the Attenuation screen, press **Menu/Exit** once.

Coarse Signal Delay: Sets the coarse signal delay in each channel. Twist each channel's Encoder knob to vary the delay. The delay step size is speed sensitive.

Coarse Signal Delay in the LCD screen corresponds to Coarse Signal Delay in IQwic > I-Tech control panel > Signal Path Tab > Delay block.

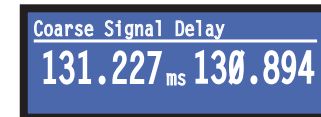

Fine Signal Delay: Sets the fine signal delay in each channel. Twist each channel's Encoder knob to vary the delay. The delay step size is speed sensitive.

Fine Signal Delay in the LCD screen corresponds to Fine Signal Delay in IQwic > I-Tech control panel > Signal Path Tab > Delay block.



Output Polarity: Press each channel's Encoder knob to toggle the output signal polarity between + and -.

Output Polarity in the LCD screen corresponds to the Polarity buttons in IQwic > I-Tech control panel > Signal Path Tab > Output Section block.



Bandpass Gain: In each channel of the I-Tech's DSP, just before the output limiter and after the preceding filter, is a gain block (not shown on the Signal Path block diagram). Bandpass Gain adjusts the gain of this block.

Adjusting the bandpass gain in the LCD screen makes it easy to vary the level of subwoofers, midrange drivers and high-frequency drivers.

Rotate each channel's Encoder knob to adjust the gain of that channel's bandpass filter.

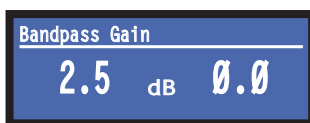

4.2.4 MONITOR MENU

This menu lets you monitor the status of the amplifier. Starting from the Attenuation Screen, press **Menu**, then press **Prev**. Or, starting from the Advanced Menu screen, press **Next** to go to the Monitor Menu screen. Then press an Encoder knob to enter the menu.



Load Monitoring: Press an Encoder knob (or use IQwic) to turn speaker load monitoring off or on. When on, the load connected to the amplifier output is displayed. The text below the reported load indicates whether the value is within the limits set in IQwic or System Architect. LOW means the load is below limits; HIGH means the load is above limits. NORMAL means the load is within limits.



Thermal %: This indicates the amplifier temperature in percent, where 100% is the maximum allowable temperature. If Thermal % reaches 100%, the amplifier is out of thermal headroom and has shut down (or will very soon).



AC Voltage: This shows the AC line voltage at the AC cord inlet to the amplifier.



Firmware Versions: Displays the firmware versions of the Display and DSP. The two may not always match. Go to www.crownaudio.com to see what firmware is available.



Manufacturing Info: Displays the amplifier model, serial number, and date code.

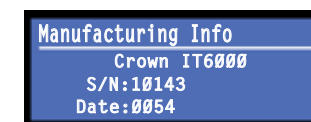

Networking: Displays the amplifier's IP address, subnet mask, HiQnet or IQ address, and MAC address.

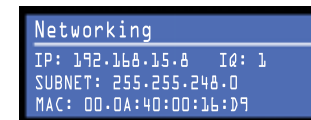

Operating Time: This displays the number of hours the amplifier has been on since manufacture. Like a car's odometer, it shows the total amount of operating hours and cannot be reset. All I-Techs come with a variable amount of operating time on them due to burn-in and testing before shipping.



Note: To prolong the life of the memory devices, this value is stored only every 30 minutes. For this reason, operating time serves only as a general means of determining how long the amplifier has been "on."

4 Advanced Operation

Clip Errors: This screen lets you view clip errors without using IQwic or System Architect. A *clip error* occurs if the number of clip events exceeds the value set with the *Count slider* (within the time set by the Time slider) on the Error Reporting Page of the IQwic Control Panel or Amplifier Settings in System Architect.

When an error occurs, the count displayed in this screen is incremented, and the operating time since the error is displayed.

To clear this screen, press and release an Encoder. The display will prompt you to confirm your choice by pressing and holding the Encoder.

NOTE: You must use IQwic or System Architect to enable error reporting and set its limits.



Thermal Errors: This screen lets you view thermal errors without using IQwic or System Architect. A *thermal error* occurs if the amplifier thermal % exceeded the value set with the *Thermal slider* on the Error Reporting Page of the IQwic Control Panel or Amplifier Settings in System Architect.

When an error occurs, the count displayed in this screen is incremented, and the operating time since the error is displayed.

To clear this screen, press and release an Encoder. The display will prompt you to confirm your choice by pressing and holding the Encoder.

NOTE: You must use IQwic or System Architect to enable error reporting and set its limits.

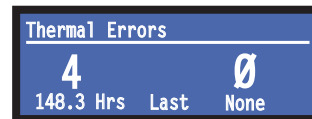

Low Limit Load Errors: This screen lets you view low-load errors without using IQwic or System Architect. A *low limit load error* occurs if the load impedance falls below the value set with the *Low Limit spin control* on the Load Monitoring Page of the IQwic Control Panel or Amplifier Settings in System Architect.

When an error occurs, the count displayed in this screen is incremented, and the operating time since the error is displayed.

To clear this screen, press and release an Encoder. The display will prompt you to confirm your choice by pressing and holding the Encoder.

NOTE: You must use IQwic or System Architect to enable error reporting and set its limits.

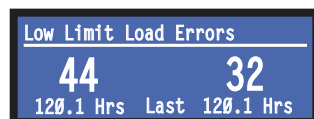

High Limit Load Errors: This screen lets you view high limit load errors without using the control software. A *high limit load error* occurs if the load impedance rises above the value set with the *High Limit* value on the software Control Panel.

When an error occurs, the count displayed in this screen is incremented, and the operating time since the error is displayed.

To clear this screen, press and release an Encoder. The display will prompt you to confirm your choice by pressing and holding the Encoder.

NOTE: You must use IQwic or System Architect to enable error reporting and set its limits.

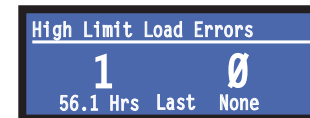

Line Voltage Errors: This screen lets you view line-voltage errors without using control software. A *line voltage error* occurs if the line voltage falls outside the values set with the *High/Low Limits slider* on the Line Voltage Page of the Control Panel.

When an error occurs, the count displayed in this screen is incremented, and the operating time since the error is displayed. The "Low" and "High" indicators show whether the line voltage was below or above the line-voltage limits.

To clear this screen, press and release an Encoder. The display will prompt you to confirm your choice by pressing and holding the Encoder.

NOTE: You must use IQwic or System Architect to enable error reporting and set its limits.

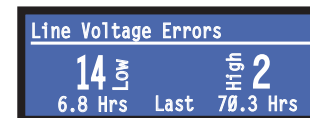

Exit: To exit the Monitor Menu and go to the Attenuation screen, press **Menu/Exit** once.

4 Advanced Operation

4.2.5 Operation Examples

Operation Example 1

How to set the CH1 input sensitivity using the LCD Control Screen:

1. After power-up, press **Menu/Exit**. The first menu item appears: the Contrast screen.
2. Press **Next** until you see "CH1 Sensitivity."
3. Turn an **Encoder** to set the sensitivity. NOTE: If you do not see the sensitivity you want, try changing the Maximum Analog Input level (see below).
4. Press **Menu/Exit**.

Operation Example 2

How to set the Maximum Analog Input level using the LCD Control Screen:

1. After power-up, press **Menu/Exit**. The first menu item appears: the Contrast screen.
2. Press **Prev** until you see "Advanced Menu."
3. Push an **Encoder** knob.
4. Press **Next** until you see "Maximum Analog Input."
5. Press an **Encoder** to change the maximum analog input level.
6. Press **Menu/Exit**.

Operation Example 3

How to monitor the Thermal Errors using the LCD Control Screen:

1. After power-up, press **Menu/Exit**. The first menu item appears: the Contrast screen.
2. Press **Prev**. You will see "Monitor Menu."
3. Push an Encoder knob.
4. Press **Next** until you see "Thermal Errors."

4.2.6 Menu Tree

As a handy reference, Figure 4.2 shows the menu structure of the LCD control screen. Once you are in a menu, you can loop through its selections using the **Next** and **Prev** buttons. The **Menu/Exit** button returns you to the Attenuation screen which you see on power-up.

You access the Monitor Menu title screen from the Attenuation screen by pressing **Menu/Exit > Prev**. You access the Advanced Menu title screen from the Attenuation screen by pressing **Menu/Exit > Prev > Prev**.

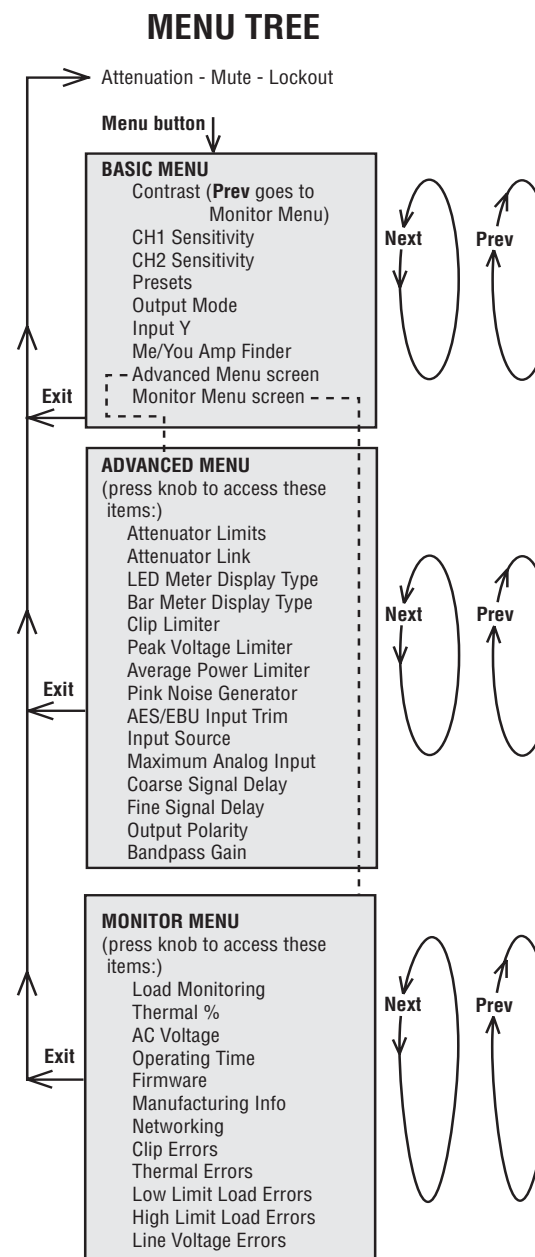

Figure 4.2 Menu Tree of the I-Tech LCD Control Screen

4 Advanced Operation

4.3 Presets

4.3.1 Introduction

Your I-Tech amplifier has a wide variety of onboard Digital Signal Processing (DSP). Some applications for this DSP are speaker configuration (setting the drive levels, frequency bands, delays and limiting for your particular speakers), EQ, filtering, compression, and much more. Those functions are described in Section 4.6. IQwic or System Architect software lets you adjust the DSP settings, such as filter slope, compression ratio, EQ frequency bands, and so on.

A **preset** is a group of DSP settings that configure the amp for a specific application. For example, you might use one preset that optimizes the amp's DSP for a JBL Vertec Line Array. You might use another preset that sets up the DSP for a stereo pair of loudspeakers of your choice. You can choose any of 20 presets with the LCD Control Screen.

The I-Tech amplifier works with two types of presets:

- 1. User presets.** Using IQwic or System Architect, you can create your own custom DSP presets, label them, and send them to the I-Tech amplifier. The amp stores those presets in firmware. You can recall those presets from the LCD Control Screen.
- 2. Downloadable presets.** Crown and JBL engineers have designed presets that are optimized for various JBL loudspeakers, such as Vertec Line Arrays. You can download presets from http://www.crownaudio.com/amp_htm/itech-download.htm. Then in the software, send the preset files to the I-Tech amplifier, where you can recall them from the LCD Control Screen.

We will describe each type of preset in detail.

4.3.2 User Presets

User presets are DSP presets that you set up. This is the basic procedure:

1. Adjust the DSP settings as desired in the IQwic or System Architect software (not with the LCD Control Screen).
2. Save this group of settings as preset. Give it a label.
3. Download the preset to the I-Tech amplifier. See the software Help file for details. Basically, you will open and engage a data frame.
4. Select that preset from the LCD Control Screen. The preset will automatically set the DSP parameters as you set them up in IQwic.

Setting the parameters of the DSP in the I-Tech amplifier is done using the control software, not by the amplifier's LCD Control Screen. For example, if you want to set filter Q, compression ratio, or graphic EQ, you would do so within the IQwic software.

After setting the DSP parameters as desired,

1. Save them as a preset in the software. Presets are stored and recalled through the Presets Page in IQwic. See the Presets Help file in IQwic for details. In System Architect, Presets are stored and recalled from the main panel. Descriptions are edited on the General page.
2. Download the preset to the I-Tech amplifier. See the Help file for details. Basically, you will open and engage a data frame.
3. When you want to recall the preset, select it on the LCD Control Screen.

4.3.3 Downloadable Presets

Crown and JBL engineers have designed I-Tech DSP presets that are optimized for various JBL loudspeakers, such as Vertec Line Arrays. To use them, follow this procedure in IQwic:

1. Go to the I-Tech website at www.crownaudio.com/itech/.
2. Select Downloads.
3. Click on the file of your choice. It will download to your computer.
4. In IQwic, select File > Open. Browse to the downloaded preset file and open it.
5. In IQwic, see the Help file on Presets for details on downloading the preset to an I-Tech amplifier. Basically, you will open and engage a data frame. The file will overwrite the preset you designate.
6. Recall the preset from the LCD Control Screen. Then your amp will be configured to work with the specified loudspeaker model.

4.4 Digital Audio Options (AES/EBU)

Digital audio inputs allow you to keep the amplifier input signals in the digital domain. Keeping the input signal digital reduces the number of Digital-to-Analog and Analog-to-Digital conversions. This provides better sound quality and reduces pickup of electrical interference.

The AES/EBU connector provides the most widely accepted format. Connect an AES/EBU signal to the AES/EBU connector on the rear panel.

4.5 Network Setup Wizard

The network setup wizard can assist you in setting up your TCP/IQ network for the first time. Using the wizard, you can address your components and be informed of addressing and other errors in the system. Please note that this wizard is designed to work with devices that are on the same physical network segment as the computer it is running on. It will not work through a router.

Select Network Card

The first page of the wizard lists all the network adapters currently in the computer. If you have more than one adapter, you can scroll through the list and see the **IP Address**, **Subnet Mask** and **Gateway** address assigned to each card.

If you have a card with an IP address of 0.0.0.0, it typically means one of several things:

1. The card is disabled.
2. The card is not connected to a network.
3. The card is setup to obtain it's address from a DHCP server, and no DHCP server is available.

Select the card that is connected to the TCP/IQ system and click the **Next** button.

Address Devices on the Network

The box labeled **Check for Errors** will report to you if any devices in the system have misconfigured IP addresses, or if there are duplicate IP or IQ addresses in the system. If there are, what happens next is dependent on what **Action to Take** is selected:

Readdress all devices - this selection will be the default if 10 or more addressing errors are found in the system. This selection will bring up another page in the wizard where you can readdress all the devices in the system.

Fix errors individually - this selection will be the default if 1 to 9 addressing errors are found in the system. This selection will bring up another page in the wizard where the errors will be listed and you will have the opportunity to fix each error individually.

No action at this time - this selection will be the default if no addressing errors are found.

Select an **Action to Take** and click **Next**.

Readdress All Components

This page gives you the opportunity to assign IP and, optionally, IQ addresses to all devices in the system. The default values will **Assign IP addresses** (including **Subnet Mask** and **Gateway** address) that match the addresses assigned to the selected network adapter in the computer. You can also **Assign IQ Addresses** by checking the appropriate box and assigning a range of addresses.

The wizard is able to avoid assigning IP addresses used by other TCP/IQ components, but it cannot detect if it has assigned an address that is currently being used by another computer or TCP/IP device on the network. If you have other computers or TCP/IP devices on the network, be sure to assign a range of addresses that does not conflict with the addresses assigned to these network nodes.

Click the **Readdress** button to initiate the readdress process. The wizard will assign addresses to, and reboot, each TCP/IQ device on the network.

When the readdressing process is finished, click the **Back** button to check again for errors, or the **Finish** button when you are ready to close the wizard.

Fix Errors Individually

This page gives you a list of each error detected in the system. Select the error you want to fix in the list, then click **Fix Error**. A dialog will be displayed that will give the opportunity to change the addresses of the offending device. Clicking OK on this dialog will change the address on the selected device, reboot that device, and remove the error from the list.

When you are done fixing errors, click the **Back** button to check again for errors, or the

Finish button when you are ready to close the wizard.

4 Advanced Operation

4.6 Software-Controllable Onboard DSP

Crown's latest-generation Digital Signal Processing is built into the I-Tech amplifier. Its 24-bit/96kHz converters offer extremely low noise and extended dynamic range. When you use an I-Tech amp, the loud-speaker processors, crossovers, limiters and delays are in the onboard DSP – so you don't need those rack-mounted devices. This drastically cuts setup time, commissioning, rack space and costs.

The I-Tech's DSP can be monitored and controlled with a computer running IQwic or System Architect software, and connected to the amplifier Network Connector by a network Category 5 cable.

Some applications for this DSP are:

- Set up signal flow
- Optimize system gain structure
- Set up speaker configurations (set the drive levels, frequency bands, delays and limiting for your particular speakers)
- Set up EQ, filtering, compression, and much more.

Listed below are the available DSP functions.

4.6.1 User Presets

The control settings for all the functions can be stored as presets. Up to 20 presets can be saved in the I-Tech amp's nonvolatile memory. Each preset can be named with a 30 character name describing its function, which is also stored in memory.

- The **Store Preset Control** saves the current setting to the specified preset.
- The **Recall Preset Control** recalls the specified preset settings.
- The **Preset Valid Monitor** indicates if a change has been made to any setting since the last time a preset has been saved or recalled.
- The **Last Stored or Recalled Preset Monitor** indicates what preset is in use.

4.6.2 Clip Event Monitor

A clip detector is provided each channel. These monitors will indicate any clip condition (> 0.05% distortion) in the amplifier channel. The clip detectors also can indicate Thermal Level Control limiting or incorrect setting of Stereo/Bridge-mono mode in the LCD-screen menu.

4.6.3 Input Signal Level Monitor

The input signal level of each channel can be monitored. The measurement range is from 0dBFS to –60dBFS with 0.5dB resolution. Each audio channel has the following monitors:

- **Analog Audio Input:** The audio input at the Balanced Audio Inputs of the I-Tech amplifier.
- **Switched Audio Input:** The audio input after the Input Audio Router.

4.6.4 Output Signal Level Monitor

The output signal level of each channel can be monitored. The measurement range is from 0 dB to –40 dB with 0.5 dB resolution. The monitors are scaled so that 0 dB is referenced to the full rated output voltage of the amplifier.

4.6.5 Thermal Headroom Level Monitor

The thermal headroom level of each channel can be monitored with the software. This level represents the percent of available power/thermal capacity that is currently being used within the output section of the amplifier. When the thermal headroom level reaches 100%, the amplifier cannot produce any more power and it will begin to protect the output devices by limiting their drive level. The thermal limiter feature of the I-Tech's DSP can be set to engage at a pre-selected thermal level.

4.6.6 Power/ Standby Control

Each channel can be independently turned on and off.

4.6.7 Signal Mute

The output signal of each channel can be independently muted. This function produces 60 dB or more of attenuation.

4.6.8 Polarity Inverter

The input signal polarity of each channel can be independently inverted.

4.6.9 Dynamic Gain Monitors

These indicators let the user monitor the actual signal path gain. The actual gain may vary from the input attenuator settings as a result of compression and limiting. On standard IQwic software control panels, these indicators appear as flying ghost faders behind the input attenuator controls. System Architect has a separate meter for gain reduction.

4.6.10 Amplifier Information

Information about the amplifier is stored in the software system inventory and is displayed on the software control panels. Information includes manufacturer, model, date code, and serial number.

4.6.11 User and Channel Labels

The I-Tech amplifier can store two user labels and two channel labels. These labels are 30-character strings that can be set by the user to indicate the function of the amplifier and its channels. For example, "LOWER RIGHT CLUSTER, FOR DELAY."

4.6.12 Line Voltage Monitor

The AC line voltage supplied to the amplifier can be displayed with this function. No user input is required.

4.6.13 Error Reporting

The I-Tech amplifier can detect four different error conditions per channel and errors in the AC line voltage. Each error type can be individually configured to report the error through the network and/or the AUX port. Network reported errors appear in the control software Error Window. The IQwic software offers many options to further report errors, including audible alerts, printout, email, pager, serial port and fax. System Architect has logs as well as email. The following describes each error source.

CLIP: The I-Tech can be configured to report if an excessive number of clip events occur in either amplifier channel. The clip events are considered an error if they exceed the defined count per the defined unit of time. The **Count** Control sets the maximum number of events before the error is reported. The range is 1 to 100. The **Time** Control defines the amount of time that the events are counted before starting the counting process over. Its range is 1 to 10 seconds. Note: Clip events are defined as the start of each clip and every 10 milliseconds the amplifier is in clip thereafter. Using a high count setting with a short time setting may result in clip error never being detected.

THERMAL: Errors can be generated for excessive temperature in the output section of the amplifier channel. The **Threshold** Control sets the level that, if exceeded, will generate the error report. This control has a range of 1 to 100%.

LOAD: If the load monitoring feature is activated, an error report can be generated if the load impedance moves outside the pre-selected range.

LINE VOLTAGE: The AC line voltage can be monitored and an error generated whenever the voltage is outside of the limits set by the software.

4 Advanced Operation

4.6.14 Input Signal Compressor/Limiter

An input signal compressor/limiter is available for each channel. Five parameters control this feature:

Enable: Enables or disables this function.

Threshold: Sets the level, in dBu, above which the compressor begins to attenuate the input signal. This level corresponds to the input level meter reading. The compressor is “feed-forward,” meaning that the level detection point is located before the gain control stage. The range is from +20 dBu to –50 dBu.

Hysteresis: A “dead zone” that ensures a significant change before acting. The range is from 0 to 12 dB. It requires the signal to go above the upper threshold before engaging and to go below the lower threshold before releasing. Not available in System Architect.

Attack Time: Sets the attack time of the compressor. The attack time is defined as the time it takes the compressor to attenuate the signal gain by 20 dB. The range is from 1 millisecond to 0.1 second.

Release Time: Sets the release time of the compressor. The release time is defined as the time it takes the compressor to increase the signal gain by 20 dB. The range is from 10 milliseconds to 10 seconds.

Compression Ratio: Sets the compression ratio of the compressor. The ratio is the relation between the amount of attenuation applied by the compressor versus the amount that the input signal is over the threshold. The available settings are 2:1 to 32:1.

Beyond the three controls for each channel, a single-control **Compressor Tie** connects the compressors together. The compressors are tied at their sense points, meaning that the greater of the two input signals will be used as stimulus for both compressors. Each compressor will still compress based on its individual threshold, attack, release and ratio settings. Not available in System Architect.

4.6.15 Peak Voltage Limiter

This limits the peak voltage output of the amplifier. Four parameters control this limiter for each channel:

Enable: Enables or disables this function.

Threshold: Sets the level, in absolute voltage, which the limiter will allow from the amplifier. The range is from $12 V_{pk}$ to $255 V_{pk}$.

Attack Time: Sets the attack time of the limiter. The attack time is defined as the time it takes the limiter to attenuate the output signal by 20 dB. The range is from 1 millisecond to 100 milliseconds.

Release Time: Sets the release time of the compressor. The release time is defined as the time it takes the limiter to increase the output signal by 20 dB. The range is from 10 milliseconds to 10 seconds.

4.6.16 Average Power Limiter

This limits the long-term output power of the amplifier. Four parameters control this limiter for each channel:

Enable: Enables or disables this limiter.

Threshold: Sets the average power level, in watts, which the limiter will allow from the amplifier channel. The range is from 10 watts to 10,000 watts. This level should be set to the connected loudspeaker's long-term power rating. Also you must enter the loudspeaker's nominal impedance.

Attack Time: Sets the attack time of the limiter. The attack time is defined as the time it takes the limiter to attenuate the output signal by 20 dB. The range is from 1 second to 30 seconds.

Release Time: Sets the release time of the compressor. The release time is defined as the time it takes the limiter to increase the output signal by 20 dB. The range is from 1 second to 30 seconds.

4.6.17 Clip Eliminator

This limiter monitors the clip events and attenuates the input signal to prevent amplifier clipping. The attack and release times are preset to optimum rates. Only one parameter controls this limiter. “Enable” enables or disables this limiter.

4.6.18 Limiter Tie (not available in System Architect)

This control forces both channels to track by using the greatest (worst case) attenuation of any limiter from either channel. With this option disabled, each channel will independently take the greatest attenuation of its own four limiters (voltage, power, clip, thermal) and ignore the limiting of the other channel. Note that this function does not include the effects of the input compressors. To tie the input compressors, use the Compressor Tie function.

4.6.19 Load Supervision

The load supervision feature allows real-time monitoring of the load connected to each amplifier channel. When enabled, the I-Tech continuously monitors the amplifier output voltage and current, and calculates the long-term average load impedance. The measured load impedance is compared against the user-defined high and low limits. If either limit is exceeded, the status indicator and, if enabled, the IQwic Error Reporting functions alert the user of the problem. There are six controls and two indicators for each channel:

Enable: Enables or disables the load-supervision function.

High Limit: Sets the upper bound above which the system will report a “high” error status.

Low Limit: Sets the lower bound below which the system will report a “low” error status.

Nominal Load Impedance: Sets the expected average impedance for the connected load. This value determines the output signal level required for the test. This parameter is also used by the average power limiter to determine the expected power threshold. (See Section 4.6.16).

Report Error to Network: Enables Error Reporting to send an error report via the network so that high and low load conditions are reported to the IQ software.

Test Indicator: This indicator is active when the amplifier output signal is sufficient to allow load impedance calculation and test verification.

Low/Normal/High Indicator: This indicator shows the present status of the load impedance with respect to the user-defined high and low limits.

Z Average Monitor: Reports the actual calculated average load impedance in ohms. Its range is from 0 ohms to 250 ohms.

4.6.20 Memory Backup Configuration

In normal operation, the I-Tech amplifier stores all its settings in non-volatile memory. When the power is removed from the amplifier and then restored, the amplifier uses these backed-up settings for its functions. This feature can be disabled with the memory backup enable

4 Advanced Operation

control. When the memory backup is disabled, the amplifier stops storing changes made to its settings. When the next power-up occurs the amplifier uses the settings that were active when the backup feature was disabled.

CAUTION: Care should be taken to backup “safe” levels for the input attenuator controls. It is possible for the memory backup feature to be disabled with “unsafe” levels stored. This may result in significantly greater system gain the next time power is reapplied to the amplifier.

4.6.21 Input Signal Router

Each channel of the I-Tech's signal processing has an Input Signal Router that allows the choice of audio signal that will be used by the channel. The user may choose one of the following configurations:

- **Analog Audio:** This is the audio input from the audio connector on the back panel of the amp. Choices for the Analog Audio input are Channel 1, Channel 2, or a sum of Channels 1 and 2.
- **Digital Audio:** This is the audio input from the AES/EBU connector on the back panel of the amp.

4.6.22 Filters

Each audio channel has five separate places where filters can be placed in the system. Up to 64 filters are available within the system. In addition to filtering, each possesses up to +/-24dB of gain. The following filters are available:

- Lowpass: Bessel 2-4, Butterworth1-4, and Linkwitz-Riley 8
- Highpass: Bessel 2-4, Butterworth1-4, and Linkwitz-Riley 8
- Lowshelf: Low-frequency shelving EQ
- Highshelf: High-frequency shelving EQ
- Lowpass EQ: Variable Q from 0.1 to 35
- Highpass EQ: Variable Q from 0.1 to 35
- Parametric EQ: Variable Q from 0.1 to 35
- All Pass: 1st and 2nd order

All Pass filters provide no gain change to the output, but provide a phase change at the selected frequency. This corrects the phase relationship of the output without a gain reduction, such as is found in other filters.

4.6.23 Delay (Latency)

Due to the nature of DSP processing, there is some inherent delay or latency within the I-Tech's DSP. These delays are:

- 1.13mS analog
- 2.36mS digital (44.1 kHz)

4.6.24 Noise Generator

Each channel has an independent uncorrected noise generator that allows noise to be mixed into the audio signal. This is useful for noise masking applications and testing. Each channel has the following controls:

- **Noise On/Off:** The channel's noise generator can be independently turned on.
- **Noise Type:** Full spectrum white noise or pink noise.
- **Noise Level:** A fader to allow the noise level to be controlled.

4.6.25 Sine-wave Generator

A sine-wave signal generator allows the mixing of a single tone into the audio signal. Typical applications can be for the injection of a high frequency tone (19kHz) into the signal in paging type system to continually drive the speaker, allowing continuous monitoring of the speaker load. The following controls exist:

- **Sine On/Off:** The sine-wave signal generator's function.
- **Sine Frequency:** Controllable from 20Hz to 20kHz.
- **Sine Level:** Each channel's sine-wave signal level can be independently controlled.

5 Troubleshooting

Fault	—	●			
Thermal	—	●			
Clip	—	●		POSSIBLE REASON <ul style="list-style-type: none"> • The amplifier has lost AC power. • The amplifier is not plugged into the power receptacle. • Rear-panel breaker is off. 	
-10	—	●			
-20	—	●			
Signal	—	●			
Ready	—	●			
	Power	●			
	Bridge	●			
	Data	●			

CONDITION: Power indicator is off and power switch is not illuminated.

Fault	—	●			
Thermal	—	☀			
Clip	—	●		POSSIBLE REASON: <ul style="list-style-type: none"> • The amplifier is becoming too hot for safe operation. Allow amplifier to cool. Check for loads less than 2 ohms, and for excessive input levels. Check for proper ventilation. 	
-10	—	●			
-20	—	●			
Signal	—	●			
Ready	—	●			
	Power	☀			
	Bridge	○			
	Data	○			

CONDITION: Thermal indicator is on.

Fault	—	●			
Thermal	—	●			
Clip	—	●		POSSIBLE REASON <ul style="list-style-type: none"> • The amplifier's Power switch is off. 	
-10	—	●			
-20	—	●			
Signal	—	●			
Ready	—	●			
	Power	●			
	Bridge	●			
	Data	●			

CONDITION: Power indicator is off and power switch is illuminated.

Fault	—	◐			
Thermal	—	●			
Clip	—	●		POSSIBLE REASON: <ul style="list-style-type: none"> • The amplifier channel has stopped operating. Refer the unit to an authorized Crown Service Center. 	
-10	—	●			
-20	—	●			
Signal	—	●			
Ready	—	●			
	Power	☀			
	Bridge	●			
	Data	●			

CONDITION: Fault indicator is flashing.

Fault	—	●			
Thermal	—	●			
Clip	—	●		POSSIBLE REASON: <ul style="list-style-type: none"> • The AC line voltage has dropped below 15% or has risen above 15% of the rated range. 	
-10	—	●			
-20	—	●			
Signal	—	●			
Ready	—	●			
	Power	◐			
	Bridge	●			
	Data	●			

CONDITION: Power indicator is flashing.

Fault	—	●			
Thermal	—	●			
Clip	—	☀		POSSIBLE REASON: <ul style="list-style-type: none"> • Load is wired incorrectly or Output Mode switch in LCD-screen menu is set incorrectly. Check both. • Input is overloaded by a signal level that is too high. Turn down your amplifier level controls (Encoders), or turn down the input signal, until the clip light goes out. 	
-10	—	☀			
-20	—	☀			
Signal	—	☀			
Ready	—	☀			
	Power	☀			
	Bridge	○			
	Data	○			

CONDITION: Distorted sound.

Note: If the signal sounds distorted even though the Clip LED is off, the input signal may be distorted before it reaches the amplifier input. Check gain staging and output levels of the mixer or preamp.

"Off/Flashing/On" means that the LED can be off, or flashing, or on.

Key	Symbol	Meaning
	●	Off
	◐	Flashing
	○	Off/Flashing/On
	☀	Lit

5 Troubleshooting

<p>Fault ———●</p> <p>Thermal ———●</p> <p>Clip ———●</p> <p>-10 ———●</p> <p>-20 ———●</p> <p>Signal ———☀</p> <p>Ready ———☀</p>	<p>Power ☀</p> <p>Bridge ○</p> <p>Data ○</p> 	<p>CONDITION: No sound, even though the amp has power. Power LED is on without flashing and the amp is receiving an input signal. Signal indicator is on or flashing.</p> <p>POSSIBLE REASON:</p> <ul style="list-style-type: none"> • Speakers not connected. • Open circuit due to speaker failure.

<p>Fault ———●</p> <p>Thermal ———●</p> <p>Clip ———●</p> <p>-10 ———●</p> <p>-20 ———●</p> <p>Signal ———●</p> <p>Ready ———☀</p>	<p>Power ☀</p> <p>Bridge ○</p> <p>Data ○</p> 	<ul style="list-style-type: none"> • There is a short on the amplifier output. First disconnect your speakers from the affected channel(s) one by one to determine if one of the loads is shorted.

<p>Fault ———●</p> <p>Thermal ———●</p> <p>Clip ———●</p> <p>-10 ———●</p> <p>-20 ———●</p> <p>Signal ———●</p> <p>Ready ———●</p>	<p>Power ☀</p> <p>Bridge ●</p> <p>Data ●</p> 	<ul style="list-style-type: none"> • Ready LED is off. Channel has been set to standby mode via the software.

<p>Power ☀</p> <p>Bridge ○</p> <p>Data ●</p> 	<p>CONDITION: Data indicator not flashing, even though host computer IQ software is active.</p> <p>POSSIBLE REASON:</p> <ul style="list-style-type: none"> • Cable between computer and amplifier is broken or not connected. <p>Note: Data indicator flashes only when the amplifier is polled for data, or is polled to see whether it is online.</p>
--	--

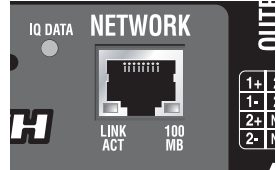
	<p>CONDITION: Yellow LINK ACTIVITY indicator in Ethernet connector does not illuminate or flash.</p> <p>POSSIBLE REASON:</p> <ul style="list-style-type: none"> • Ethernet link is broken.
---	---

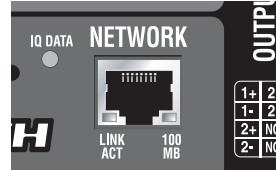
	<p>CONDITION: Yellow LINK ACT indicator is on but green 100Mb indicator in Ethernet connector does not illuminate.</p> <p>POSSIBLE REASON:</p> <ul style="list-style-type: none"> • Network connection is 10Mb. The I-Tech can work on a 10Mb connection but 100Mb is optimum.
--	---

<p>Fault ———●</p> <p>Thermal ———●</p> <p>Clip ———●</p> <p>-10 ———●</p> <p>-20 ———●</p> <p>Signal ———●</p> <p>Ready ———☀</p>	<p>Power ☀</p> <p>Bridge ○</p> <p>Data ○</p> 	<p>CONDITION: No input signal. Signal indicator is not flashing even though audio is applied, and the channel is ready.</p> <p>POSSIBLE REASON:</p> <ul style="list-style-type: none"> • Input signal level is very low.
---	--	---

<p>CONDITION: Computer does not communicate with the network devices.</p> <p>POSSIBLE REASON:</p> <ul style="list-style-type: none"> • Incorrect wiring. See Section 4.5.4 on wiring. • IP Addressing is not done correctly. See Section 4.5.5 on addressing rules.

6 Specifications

6.1 Performance

Minimum Guaranteed Power	I-T4000	I-T6000	I-T8000
20 Hz - 20 kHz with 0.35% THD			
Stereo, 2 ohms (per ch.)	1800W	2500W	3500W
Stereo, 4 ohms (per ch.)	2000W	3000W	4000W
Stereo, 8 ohms (per ch.)	1250W	1500W	2100W
Bridge mono, 4 ohms	3600W	5000W	7000W
Bridge mono, 8 ohms	4000W	6000W	8000W
Performance	I-T4000	I-T6000	I-T8000
Input Sensitivity (volts RMS) for rated output	Adjustable in 0.1V steps from 1.4V to 7.75V	Adjustable in 0.1V steps from 1.4V to 7.75V	Adjustable in 0.1V steps from 1.4V to 7.75V
Voltage Gain for full rated power at 8 ohms	37.1 dB to 22.2 dB	37.9 dB to 23.0 dB	39.3 dB to 24.5 dB
Frequency Response (at 1 watt, 20Hz - 20 kHz)	± 0.25 dB	± 0.25 dB	± 0.25 dB
Signal to Noise Ratio below rated full-bandwidth power, A-weighted	> 105 dB	> 105 dB	> 105 dB
Total Harmonic Distortion (THD) at full rated power	< 0.35%	< 0.35%	< 0.35%
Intermodulation Distortion (IMD) 60 Hz and 7 kHz at 4:1, from full rated output to -35 dB	< 0.35%	< 0.35%	< 0.35%
Maximum Input Level	+15 dBu or +21 dBu, depending on setting of maximum input level	+15 dBu or +21 dBu, depending on setting of maximum input level	+15 dBu or +21 dBu, depending on setting of maximum input level
Latency (analog, digital inputs)	Analog: 1.13 mS. Digital: See Table 5 below.	Analog: 1.13 mS. Digital: See Table 5 below.	Analog: 1.13 mS. Digital: See Table 5 below.
A/D, D/A Converters	24-bit 96 kHz Cirrus Logic	24-bit 96 kHz Cirrus Logic	24-bit 96 kHz Cirrus Logic
Digital Input	AES/EBU, 24-bit, 32-96 kHz. Onboard sample rate converter.	AES/EBU, 24-bit, 32-96 kHz. Onboard sample rate converter.	AES/EBU, 24-bit, 32-96 kHz. Onboard sample rate converter.
Network	Onboard HiQnet and TCP/IQ, compatible with standard 100Mb Ethernet hardware	Onboard HiQnet and TCP/IQ, compatible with standard 100Mb Ethernet hardware	Onboard HiQnet and TCP/IQ, compatible with standard 100Mb Ethernet hardware
DSP	24-bit conversion with 32-bit, floating-point DSP processing	24-bit conversion with 32-bit, floating-point DSP processing	24-bit conversion with 32-bit, floating-point DSP processing
Attenuators	Speed-sensitive rotary encoders, 0.5 dB steps, range 0 to -100 dB.	Speed-sensitive rotary encoders, 0.5 dB steps, range 0 to -100 dB	Speed-sensitive rotary encoders, 0.5 dB steps, range 0 to -100 dB

Table 5 Latency (digital inputs)

Sample rate	Latency
32 kHz	2.74 mS
44.1 kHz	2.36 mS
48 kHz	2.28 mS
96 kHz	1.81 mS

6 Specifications

Performance	I-T4000	I-T6000	I-T8000
Damping Factor (8 ohms): 20 Hz to 100 Hz	> 5000	> 5000	> 5000
Crosstalk (below rated power, 20 Hz to 1 kHz)	> 80 dB	> 80 dB	> 80 dB
Common Mode Rejection (CMR) (20 Hz to 1 kHz)	> 50 dB	> 50 dB	> 50 dB
DC Output Offset (Shorted input)	< ± 3 mV	< ± 3 mV	< ± 3 mV
Input Impedance (nominal)	20 kilohms balanced, 10 kilohms unbalanced	20 kilohms balanced, 10 kilohms unbalanced	20 kilohms balanced, 10 kilohms unbalanced
Load Impedance (Note: Safe with all types of loads) Stereo Bridge Mono	1-2-4-8-16 ohms 2-4-8 ohms	1-2-4-8-16 ohms 2-4-8 ohms	1-2-4-8-16 ohms 2-4-8 ohms
Required AC Mains	Universal AC input, 100-240VAC (±10%), 50/60 Hz. Max. AC mains voltage 264VAC.	Universal AC input, 100-240VAC (±10%), 50/60 Hz. Max. AC mains voltage 264VAC.	Universal AC input, 100-240VAC (±10%), 50/60 Hz. Max. AC mains voltage 264VAC.
AC Line Connector	USA, UK, European, Australia, India	USA, UK, European, Australia, India	USA, UK, European, Australia, India
Construction	I-T4000	I-T6000	I-T8000
Ventilation	Flow-through ventilation from front to back	Flow-through ventilation from front to back	Flow-through ventilation from front to back
Cooling	Dual-zone, microprocessor controlled, continuously variable speed fans	Dual-zone, microprocessor controlled, continuously variable speed fans	Dual-zone, microprocessor controlled, continuously variable speed fans
Dimensions	EIA Standard 19-inch rack mount width (EIA RS-310B), 3.5-inch (8.9-cm) height, 16.2-inch (41.1-cm) depth behind front mounting surface	EIA Standard 19-inch rack mount width (EIA RS-310B), 3.5-inch (8.9-cm) height, 16.2-inch (41.1-cm) depth behind front mounting surface	EIA Standard 19-inch rack mount width (EIA RS-310B), 3.5-inch (8.9-cm) height, 16.2-inch (41.1-cm) depth behind front mounting surface
Weight Net Shipping	28 pounds (12.7 kg) 36 pounds (16.3 kg)	28 pounds (12.7 kg) 36 pounds (16.3 kg)	28 pounds (12.7 kg) 36 pounds (16.3 kg)

6 Specifications

6.2 Charts

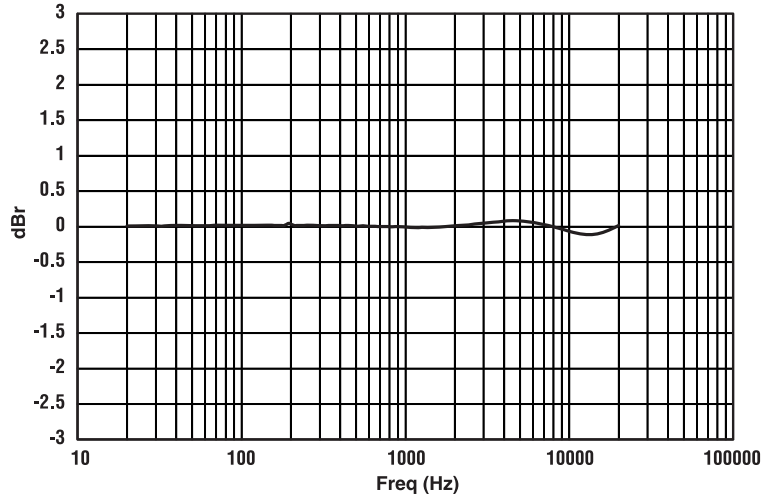

Figure 6.1 Typical Frequency Response (1W)

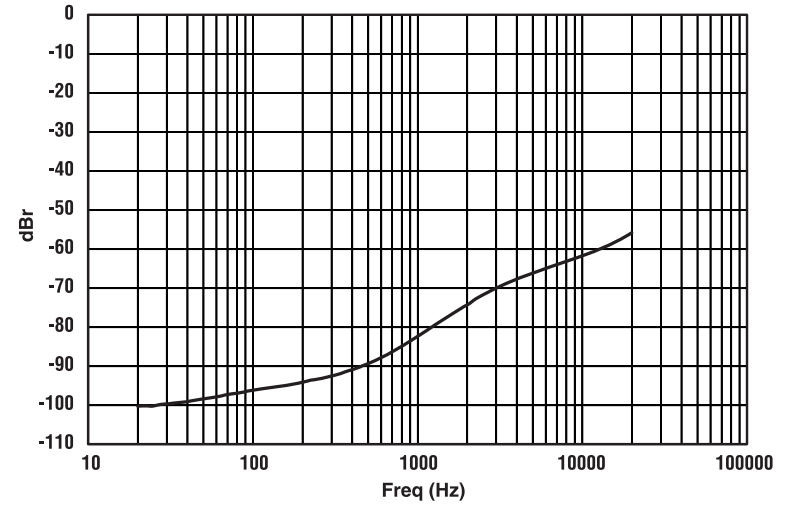

Figure 6.2 Typical Crosstalk vs. Frequency

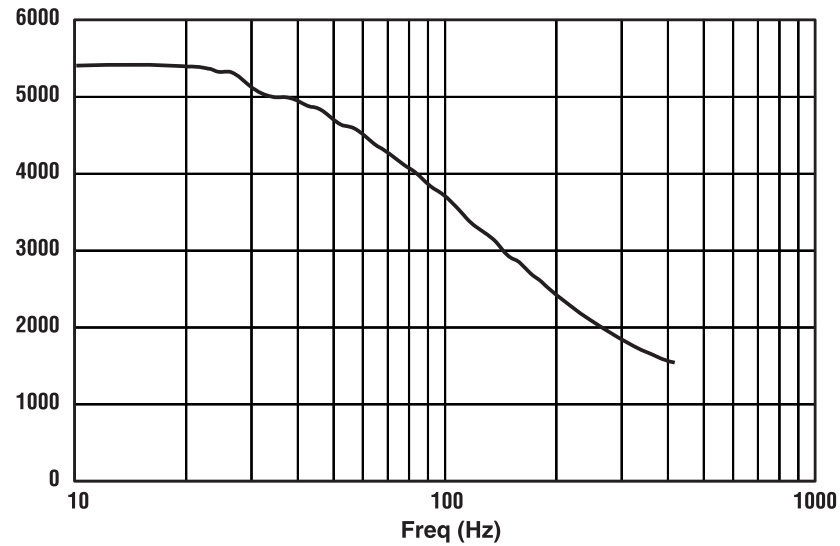

Figure 6.3 Typical Damping Factor vs. Frequency

7 AC Power Draw and Thermal Dissipation

I-Tech 4000 AC Current Draw and Thermal Dissipation:

Pink noise 12dB crest factor, bandwidth limited 22Hz to 22kHz.

Typical line impedance used.

Data based on both channels driven.

I-T4000										
	Load	120VAC		208VAC		230VAC		Watts Dissipated	Thermal Dissipation	
		Line Current 120VAC	Watts Out Per 1A Amp Line Current	Line Current 208VAC	Watts Out Per 1A Amp Line Current	Line Current 230VAC	Watts Out Per 1A Amp Line Current		Btu/hr	kcal/hr
Idle (sleep mode)		0.8		0.95		0.9		53	182	157
Idle (awake)		1.6		1.4		1.3		172	587	505
1/8th Power Pink Noise Typical of program material just at clip.	8 Ohms/Ch. 16 Ohms Bridge	5.3	59.6	3.4	94.6	3.1	102.6	305	1040	262
	4 Ohms/Ch. 8 Ohms Bridge	7.8	64.9	4.7	106.9	4.4	116.3	414	1413	356
	2 Ohms/Ch. 4 Ohms Bridge	8.0	58.1	4.8	96.1	4.4	106.0	476	1625	410
1/3rd Power Pink Noise Typical of program material with severe clipping.	8 Ohms/Ch. 16 Ohms Bridge	10.9	77.1	6.6	126.2	6.0	139.9	437	1491	376
	4 Ohms/Ch. 8 Ohms Bridge	17.8	77.0	10.5	129.1	9.5	142.1	711	2426	612
	2 Ohms/Ch. 4 Ohms Bridge	17.7	70.3	10.7	115.3	9.4	128.7	824	2814	709

7 AC Power Draw and Thermal Dissipation

I-Tech 6000 AC Current Draw and Thermal Dissipation:

Pink noise 12dB crest factor, bandwidth limited 22Hz to 22kHz.

Typical line impedance used.

Data based on both channels driven.

		I-T6000								
		120VAC		208VAC		230VAC		Thermal Dissipation		
Load		Line Current 120VAC	Watts Out Per 1A Amp Line Current	Line Current 208VAC	Watts Out Per 1A Amp Line Current	Line Current 230VAC	Watts Out Per 1A Amp Line Current	Watts Dissipated	Btu/hr	kcal/hr
Idle (sleep mode)		1.0		1.0		0.95		60	205	177
Idle (awake)		2.1		1.7		1.6		225	767	660
1/8th Power Pink Noise Typical of program material just at clip.	8 Ohms/Ch. 16 Ohms Bridge	6.6	57.6	4.2	91.2	3.8	99.8	392	1338	337
	4 Ohms/Ch. 8 Ohms Bridge	11.6	65.7	7.0	108.8	6.3	120.4	593	2024	510
	2 Ohms/Ch. 4 Ohms Bridge	11.5	55.9	6.8	96.5	6.2	105.3	695	2373	598
1/3rd Power Pink Noise Typical of program material with severe clipping.	8 Ohms/Ch. 16 Ohms Bridge	13.6	74.4	8.1	125.3	7.4	137.2	579	1977	498
	4 Ohms/Ch. 8 Ohms Bridge	27.6	73.9	16.0	127.2	14.3	141.0	1149	3921	988
	2 Ohms/Ch. 4 Ohms Bridge	25.0	67.0	14.9	113.5	13.6	124.3	1223	4173	1052

7 AC Power Draw and Thermal Dissipation

I-Tech 8000 AC Current Draw and Thermal Dissipation:

Pink noise 12dB crest factor, bandwidth limited 22Hz to 22kHz.

Typical line impedance used.

Data based on both channels driven.

I-T8000										
	Load	120VAC		208VAC		230VAC		Watts Dissipated	Thermal Dissipation	
		Line Current 120VAC	Watts Out Per 1A Amp Line Current	Line Current 208VAC	Watts Out Per 1A Amp Line Current	Line Current 230VAC	Watts Out Per 1A Amp Line Current		Btu/hr	kcal/hr
Idle (sleep mode)		0.9		1.1		1.0		62	212	183
Idle (awake)		2.0		1.8		1.6		213	726	625
1/8th Power Pink Noise Typical of program material just at clip.	8 Ohms/Ch. 16 Ohms Bridge	8.3	63.6	5.1	103.3	4.7	111.8	441	1504	379
	4 Ohms/Ch. 8 Ohms Bridge	14.6	68.8	8.7	115.2	8.0	124.5	701	2394	603
	2 Ohms/Ch. 4 Ohms Bridge	14.2	62.9	8.2	106.1	7.7	113.6	764	2607	657
1/3rd Power Pink Noise Typical of program material with severe clipping.	8 Ohms/Ch. 16 Ohms Bridge	18.1	77.4	11.0	128.3	9.9	142.0	715	2439	615
	4 Ohms/Ch. 8 Ohms Bridge	35.1	76.3	20.8	128.6	18.7	144.2	1370	4677	1179
	2 Ohms/Ch. 4 Ohms Bridge	33.9	69.2	19.9	118.0	17.9	131.1	1589	5425	1368

8 Advanced Features

8.1 Protection Systems

Your Crown amplifier provides extensive protection and diagnostic capabilities, including thermal level control, fault indicators, high-pass filtering, DC protect, AC under/over voltage protection, inrush limiting, and variable-speed fans.

8.1.1 Thermal Level Control (TLC)

If the amplifier becomes too hot for safe operation, the TLC will engage the input compressor and the clip LED will illuminate. By compressing the input, the amplifier will not generate as much heat and will have a chance to cool down. The degree of compression is proportional to the amount of overheating. This feature allows the show to go on, rather than having the amplifier shut down, and only occurs in extreme situations.

8.1.2 Circuit Breaker

If the current draw of the amplifier exceeds safe limits, this breaker automatically disconnects the power supply from the AC mains.

8.2 Global Switching Power Supply with PFC

Thanks to its global power supply, the I-Tech amplifier works anywhere in the world. There's no need to reset an AC mains voltage switch, and no need to order a special model. The amp will work and meet all specs on 100V - 240VAC, 50/60 Hz.

Crown's Switching Power Supply minimizes the amplifier's weight.

Typical non-switching power supplies require large, heavy transformers in order to produce the required power at the output stage. These transformers must be large to operate at 50 to 60 Hz (standard AC supplied by the power company).

By contrast, switching power supplies can operate with a much smaller (and lighter) transformer because they first convert the AC up to a much higher frequency, thereby reducing waste.

Power Factor Correction (PFC) controls how your amplifier draws current from the AC mains. Instead of drawing high-magnitude current spikes that reduce the capacity of your

power distro (and couple noise into other system components), PFC draws a smooth and quiet current waveform that is in phase with the mains voltage waveform. PFC allows you to reduce the size and weight of your power distribution and improve the performance of your signal processors.

8.3 3rd Generation Class I Circuitry

Class I (BCA, Balanced Current Amplifier) Interleave technology allows high levels of power output without all the associated heat found in a conventional amplifier. This highly efficient design also provides accurate, uncolored sound with very low distortion and a high damping factor for tight, clean bass response. And it can deliver more power to reactive loads than conventional dissipative designs (comfortably driving the latest high-technology transducers). Class I also reduces current draw of the AC mains, providing energy conservation.

8.4 Color-Coded Rear Overlay

The labels on the rear panel are color coded to group similar functions under common colors.

9 Appendix A: Network Basics

9.1 TCP/IQ and HiQnet Networks

Background: A **Local Area Network (LAN)** is a group of computers in a venue that share data, either through cables or via wireless transmission. **Ethernet** is a popular LAN communication protocol for PCs. An **audio network** is a Local Area Network made of audio devices and one or more computers. A **subnet** is a small network within a larger network. For example, an audio network might have two subnets: one for entertainment audio, and one for paging.

One use of an audio network is to control and monitor power amplifiers on stage from a computer at Front-of-House. You can set amplifier levels, adjust crossovers, measure speaker impedance, check for overheating and clipping, all from the house mixing console.

You need a way to send computer commands to several audio devices at once. This is done with an **Ethernet switch**, which is something like an audio Y cable or distribution amp. The computer, and all the audio devices, connect to the switch as in Figure 9.1.

TCP/IQ is a network protocol that allows you to control and monitor certain Crown and BSS audio products on an Ethernet network. **HiQnet** lets you control and monitor certain Harman products (including Crown) on an Ethernet network. Figure 9.1 shows a typical HiQnet or TCP/IQ network.

TCP/IQ and HiQnet audio networks offer many advantages:

- **Use of “off-the-shelf” network hardware.** TCP/IQ and HiQnet use standard hardware commonly used in the computer industry, making it both low-cost and readily available.
- **Better Performance.** Meters display faster in realtime because the network is wide bandwidth.

HiQnet and TCP/IQ provide these functions:

- Quickly find all HiQnet components connected to the network.
- Synchronize multiple control points on a network.
- Control and monitor components on different Local Area Networks (LANs) through the use of an IP router (explained later).
- Upgrade firmware via the network.

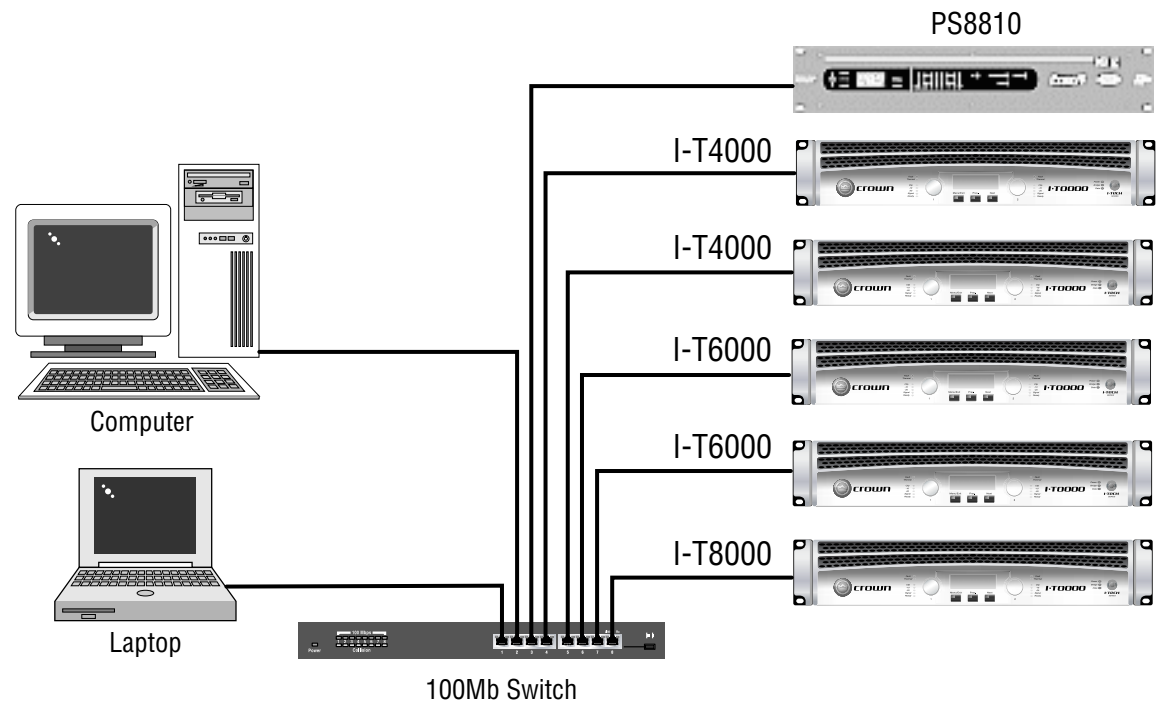

Figure 9.1 A HiQnet or TCP/IQ Network

Network Addresses

Each component in a TCP/IP or HiQNet network has three addresses to identify it:

- Media Access Control (MAC) Address
- Internet Protocol (IP) Address
- IQ or HiQNet Address

Let's explain each identifier.

MAC address: Short for Media Access Control, MAC is an address for an audio component that is burned into firmware in the component by its manufacturer, and cannot be changed. Every component in a network has its own unique MAC address. The MAC address is printed on a label outside the component. It is shown in hexadecimal format as 6 two-byte octets such as:

00-0A-40-00-DC-2F

IQ or HiQNet Address: When you set up a network with IQwic or System Architect software, you assign an IQ address to each component. Each component has its own address, numbered from 1 to 65, 535.

Internet Protocol (IP) Address: When you set up a network, you assign an IP address to each component. The IP address identifies each component. That way, certain data can be sent to the correct address (the correct component). An IP address has four numbers separated by periods. Each of the four numbers must be 0 to 255. For example:

192.168.0.1

Part of an IP address the network ID, and the remaining part is the host ID. The host ID is either:

- A subnet number and a device address.
- A device address (if there is no subnet in the network).

To identify which part of the IP address is the network ID, you assign a **Subnet Mask** to the network. A Subnet Mask is four numbers (0-255) separated by periods. "255" means "this part of the address is the network ID". For example, if the subnet mask is 255.255.0.0, and the IP address is 192.168.0.127, the network ID is 192.168.

IP Router

To communicate between different networks, you need an **IP Router**. Any control data or monitor data that is sent to the other network must go through the IP Router.

The IP address allows components and computers on multiple networks to communicate with each other through the use of an IP Router as shown in Figure 9.2.

Here is an application for a router. Wireless devices, because of bandwidth limitations, cannot be on a CobraNet network. However, the wireless devices can be on a non-CobraNet network, and access CobraNet devices through a router using IP addressing.

Discovery is the process where IQwic finds all the devices on an audio network and lists them on the computer screen. Discovery cannot be done through an IP router, so a **Discovery Proxy** is required. If you need to control or monitor components that are on

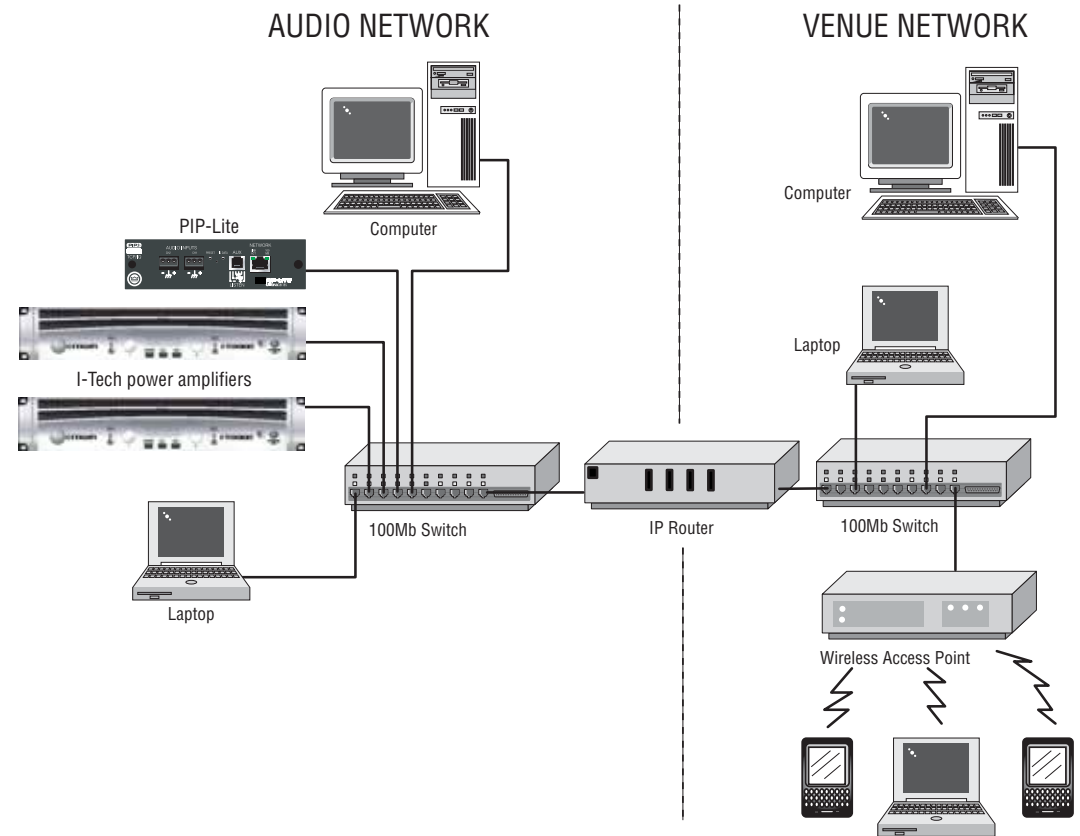

Figure 9.2 Multiple-Network Communication Via an IP Router

another subnet, you will need to specify ONE component on the remote network that can act as a Discovery Proxy. Currently, the BSS PS8810C and all networked Crown products can function in this capacity (with IQwic only).

To add a Proxy in IQwic, select Setup > Network Setup > Proxy addresses. Choose any one of the components listed above, type its IP address in the box under Proxy Addresses, then click the **Add** button. To remove a Proxy, select the IP address in the list and click the **Remove** button.

9 Appendix B: Setting Sensitivity for Best Gain Staging

Optimized system gain structure maximizes signal to noise within the system. Adjusting your amplifier to fit within an optimized system gain structure is accomplished by properly setting both the sensitivity and attenuation controls within the amplifier. I-Tech amplifiers offer 149 sensitivity and gain settings allowing very fine adjustment of the amplifier's gain and voltage sensitivity. The Appendix section of the I-Tech Application guide (online at www.crownaudio.com) provides charts with sensitivity in volts and gain in dB for each sensitivity/gain setting.

With other amplifiers, it is often necessary to apply attenuation in order to achieve the desired sound pressure level. Large amounts of attenuation are not necessary with I-Tech amplifiers and can, in fact, degrade performance. The attenuation adjustment should only be used for small (3 dB) or temporary adjustments in amplifier gain. Instead, set the sensitivity/gain of your I-Tech amplifier so that you can achieve the desired output with the attenuators at or near 0 dB.

Example: Suppose that you are using an I-T8000 with the sensitivity/gain set at 1.4V/37.1 dB. After optimizing the gain structure of the rest of your system you find that attenuating the amplifier by 10 dB produces the desired loudness. The same output level, with improved signal-to-noise ratio and headroom, can be achieved by using 0 dB of attenuation and by setting the amplifier sensitivity/gain to 5.81V/27.0 dB (37 dB – 10 dB = 27 dB).

Note: as indicated in the online appendix, the list of possible sensitivity settings is different for each position of the max input setting. If, while adjusting sensitivity/gain in your amplifier, you do not find the setting you need, try changing the status of the max input setting and search again.

10 Service

Crown amplifiers are quality units that rarely require servicing. Before returning your unit for service, please contact Crown Technical Support to verify the need for servicing.

This unit has very sophisticated circuitry which should only be serviced by a fully trained technician. This is one reason why each unit bears the following label:

CAUTION: To prevent electric shock, do not remove covers. No user serviceable parts inside. Refer servicing to a qualified technician.



Complete the Crown Audio Factory Service Information form, in the back of this manual, when returning a Crown product to the factory or authorized service center. The form must be included with your product inside the box or in a packing slip envelope securely attached to the outside of the shipping carton. Do not send this form separately.

Warranty is only valid within the country in which the product was purchased.

10.1 International and Canada Service

Service may be obtained from an authorized service center. (Contact your local Crown/Amcron representative or our office for a list of authorized service centers.) To obtain service, simply present the bill of sale as proof of purchase along with the defective unit to an authorized service center. They will handle the necessary paperwork and repair.

Remember to transport your unit in the original factory pack.

10.2 US Service

Service may be obtained in one of two ways: from an authorized service center or from the factory. You may choose either. It is important that you have your copy of the bill of sale as your proof of purchase.

10.2.1 Service at a US Service Center

This method usually saves the most time and effort. Simply present your bill of sale along with the defective unit to an authorized service center to obtain service. They will handle the necessary paperwork and repair. Remem-

ber to transport the unit in the original factory pack. A list of authorized service centers in your area can be obtained from Crown Factory Service, or online from <http://www.crownaudio.com/support/servcent.htm>.

10.2.2 Factory Service

Crown accepts no responsibility for non-serviceable product that is sent to us for factory repair. It is the owner's responsibility to ensure that their product is serviceable prior to sending it to the factory. Serviceable product list is available at <http://crownweb.crownintl.com/crownrma/>. For more information, please contact us direct.

A Service Return Authorization (SRA) is required for product being sent to the factory for repair. An SRA can be completed online at www.crownaudio.com/support/factserv.htm. If you do not have access to the web, please call Crown's Customer Service at 574.294.8200 or 800.342.6939 extension 8205.

For warranty service, we will pay for ground shipping both ways in the United States. Contact Crown Customer Service to obtain prepaid shipping labels prior to sending the unit. Or, if you prefer, you may prepay the cost of shipping, and Crown will reimburse you. Send copies of the shipping receipts to Crown to receive reimbursement. Your repaired unit will be returned via UPS ground. Please contact us if other arrangements are required.

10.2.3 Factory Service Shipping Instructions:

1. Service Return Authorization (SRA) is required for product being sent to the factory for service. Please complete the SRA by going to www.crownaudio.com/support/factserv.htm. If you do not have access to our website, call 1.800.342.6939, extension 8205 and we'll create the SRA for you.
2. See packing instructions that follow.
3. Ship product to:
CROWN AUDIO FACTORY SERVICE
1718 W MISHAWKA RD.
ELKHART, IN 46517

4. Use a bold black marker and write the SRA number on three sides of the box.
5. Record the SRA number for future reference. The SRA number can be used to check the repair status.

10.2.4 Packing Instructions

Important: These instructions must be followed. If they are not followed, Crown Audio, Inc. assumes no responsibility for damaged goods and/or accessories that are sent with your unit.

1. Fill out and include the Crown Audio Factory Service Information sheet in the back of this manual.
2. Do not ship any accessories (manuals, cords, hardware, etc.) with your unit. These items are not needed to service your product. We will not be responsible for these items.
3. When shipping your Crown product, it is important that it has adequate protection. We recommend you use the original pack material when returning the product for repair. If you do not have the original box, please call Crown at 800.342.6939 or 574.294.8210 and order new pack material. See instructions for "foam-in-place" shipping pack. (Do not ship your unit in a wood or metal cabinet.)
4. If you provide your own shipping pack, the minimum recommended requirements for materials are as follows:
 - a. 275 P.S.I. burst test, Double-Wall carton that allows for 2-inch solid Styrofoam on all six sides of unit or 3 inches of plastic bubble wrap on all six sides of unit.
 - b. Securely seal the package with an adequate carton sealing tape.
 - c. Do not use light boxes or "peanuts". Damage caused by poor packaging will not be covered under warranty.

Using your 'foam-in-place' shipping pack

Note: The foam-in-place packing is molded so that there is only one correct position for your product.

1. Open carton and lift center cushion leaving both end-cushions in place.
2. Carefully place your product with the product's front panel facing the same direction as arrows indicate.
3. Reset center cushion down over top of product's chassis. The foam-in-place packing was molded to accommodate different chassis depth sizes. If your product's chassis does not completely fill the foam-in-place cavity, you may use a soft but solid packing material (such as paper or bubble wrap) behind the chassis.
4. Enclose the completed Crown Audio Factory Service Information form (or securely attach it to the outside of carton) and re-seal the shipping pack with a sturdy carton sealing tape.

10.2.5 Estimate Approval

Approval of estimate must be given within 30 days after being notified by Crown Audio Inc. Units still in the possession of Crown after 30 days of the estimate will become the property of Crown Audio Inc.

10.2.6 Payment of Non-Warranty Repairs

Payment on out-of-warranty repairs must be received within 30 days of the repair date. Units unclaimed after 30 days become the property of Crown Audio Inc.

If you have any questions, please contact Crown Factory Service.

Crown Factory Service

1718 W. Mishawaka Rd.,
Elkhart, Indiana 46517 U.S.A.

Telephone:

574.294.8200
800.342.6939 (North America,
Puerto Rico, and Virgin Islands only)

Facsimile:

574.294.8301 (Technical Support)
574.294.8124 (Factory Service)

Internet:

<http://www.crownaudio.com>

11 Warranty



UNITED STATES & CANADA

SUMMARY OF WARRANTY

Crown International, 1718 West Mishawaka Road, Elkhart, Indiana 46517-4095 U.S.A. warrants to you, the ORIGINAL PURCHASER and ANY SUBSEQUENT OWNER of each NEW Crown product, for a period of three (3) years from the date of purchase by the original purchaser (the "warranty period") that the new Crown product is free of defects in materials and workmanship. We further warrant the new Crown product regardless of the reason for failure, except as excluded in this Warranty.

Warranty is only valid within the country in which the product was purchased.

ITEMS EXCLUDED FROM THIS CROWN WARRANTY

This Crown Warranty is in effect only for failure of a new Crown product which occurred within the Warranty Period. It does not cover any product which has been damaged because of any intentional misuse, accident, negligence, or loss which is covered under any of your insurance contracts. This Crown Warranty also does not extend to the new Crown product if the serial number has been defaced, altered, or removed.

WHAT THE WARRANTOR WILL DO

We will remedy any defect, regardless of the reason for failure (except as excluded), by repair, replacement, or refund. We may not elect refund unless you agree, or unless we are unable to provide replacement, and repair is not practical or cannot be timely made. If a refund is elected, then you must make the defective or malfunctioning product available to us free and clear of all liens or other encumbrances. The refund will be equal

to the actual purchase price, not including interest, insurance, closing costs, and other finance charges less a reasonable depreciation on the product from the date of original purchase. Warranty work can only be performed at our authorized service centers or at the factory. Warranty work for some products can only be performed at our factory. We will remedy the defect and ship the product from the service center or our factory within a reasonable time after receipt of the defective product at our authorized service center or our factory. All expenses in remedying the defect, including surface shipping costs in the United States, will be borne by us. (You must bear the expense of shipping the product between any foreign country and the port of entry in the United States including the return shipment, and all taxes, duties, and other customs fees for such foreign shipments.)

HOW TO OBTAIN WARRANTY SERVICE

You must notify us of your need for warranty service within the warranty period. All components must be shipped in a factory pack, which, if needed, may be obtained from us free of charge. Corrective action will be taken within a reasonable time of the date of receipt of the defective product by us or our authorized service center. If the repairs made by us or our authorized service center are not satisfactory, notify us or our authorized service center immediately.

DISCLAIMER OF CONSEQUENTIAL AND INCIDENTAL DAMAGES

YOU ARE NOT ENTITLED TO RECOVER FROM US ANY INCIDENTAL DAMAGES RESULTING FROM ANY DEFECT IN THE NEW CROWN

PRODUCT. THIS INCLUDES ANY DAMAGE TO ANOTHER PRODUCT OR PRODUCTS RESULTING FROM SUCH A DEFECT. SOME STATES DO NOT ALLOW THE EXCLUSION OR LIMITATIONS OF INCIDENTAL OR CONSEQUENTIAL DAMAGES, SO THE ABOVE LIMITATION OR EXCLUSION MAY NOT APPLY TO YOU.

WARRANTY ALTERATIONS

No person has the authority to enlarge, amend, or modify this Crown Warranty. This Crown Warranty is not extended by the length of time which you are deprived of the use of the new Crown product. Repairs and replacement parts provided under the terms of this Crown Warranty shall carry only the unexpired portion of this Crown Warranty.

DESIGN CHANGES

We reserve the right to change the design of any product from time to time without notice and with no obligation to make corresponding changes in products previously manufactured.

LEGAL REMEDIES OF PURCHASER

THIS CROWN WARRANTY GIVES YOU SPECIFIC LEGAL RIGHTS, YOU MAY ALSO HAVE OTHER RIGHTS WHICH VARY FROM STATE TO STATE. No action to enforce this Crown Warranty shall be commenced after expiration of the warranty period.

THIS STATEMENT OF WARRANTY SUPERSEDES ANY OTHERS CONTAINED IN THIS MANUAL FOR CROWN PRODUCTS. 9/07

11 Warranty

WORLDWIDE EXCEPT USA & CANADA



SUMMARY OF WARRANTY

Crown International, 1718 West Mishawaka Road, Elkhart, Indiana 46517-4095 U.S.A. warrants to you, the ORIGINAL PURCHASER and ANY SUBSEQUENT OWNER of each NEW Crown1 product, for a period of three (3) years from the date of purchase by the original purchaser (the "warranty period") that the new Crown product is free of defects in materials and workmanship, and we further warrant the new Crown product regardless of the reason for failure, except as excluded in this Warranty.

Warranty is only valid within the country in which the product is purchased.

¹ Note: If your unit bears the name "Amcron," please substitute it for the name "Crown" in this warranty.

ITEMS EXCLUDED FROM THIS CROWN-WARRANTY

This Crown Warranty is in effect only for failure of a new Crown product which occurred within the Warranty Period. It does not cover any product which has been damaged because of any intentional misuse, accident, negligence, or loss which is covered under any of your insurance contracts. This Crown Warranty also does not extend to the new Crown product if the serial number has been defaced, altered, or removed.

WHAT THE WARRANTOR WILL DO

We will remedy any defect, regardless of the reason for failure (except as excluded), by repair, replacement, or refund. We may not elect refund unless you agree, or unless we are unable to provide replacement, and repair is not practical or cannot be timely made. If a refund is elected, then you must make the defective or malfunctioning product available to us free and clear of all liens or other encumbrances. The refund will be equal to the actual purchase price, not including interest, insurance, closing costs, and other finance charges less a reasonable depreciation on the product from the date of original purchase. Warranty work can only be performed at our authorized service centers. We will remedy the defect and ship the product from the service center within a reasonable time after receipt of the defective product at our authorized service center.

HOW TO OBTAIN WARRANTY SERVICE

You must notify your local Crown importer of your need for warranty service within the warranty period. All components must be shipped in the original box. Corrective action will be taken within a reasonable time of the date of receipt of the defective product by our authorized service center. If the repairs made by our authorized service center are not satisfactory, notify our authorized service center immediately.

DISCLAIMER OF CONSEQUENTIAL AND INCIDENTAL DAMAGES

YOU ARE NOT ENTITLED TO RECOVER FROM US ANY INCIDENTAL DAMAGES RESULTING FROM ANY DEFECT IN THE NEW CROWN PRODUCT. THIS INCLUDES ANY DAMAGE TO ANOTHER PRODUCT OR PRODUCTS RESULTING FROM SUCH A DEFECT.

WARRANTY ALTERATIONS

No person has the authority to enlarge, amend, or modify this Crown Warranty. This Crown Warranty is not extended by the length of time which you are deprived of the use of the new Crown product. Repairs and replacement parts provided under the terms of this Crown Warranty shall carry only the unexpired portion of this Crown Warranty.

DESIGN CHANGES

We reserve the right to change the design of any product from time to time without notice and with no obligation to make corresponding changes in products previously manufactured.

LEGAL REMEDIES OF PURCHASER

No action to enforce this Crown Warranty shall be commenced after expiration of the warranty period.

THIS STATEMENT OF WARRANTY SUPERSEDES ANY OTHERS CONTAINED IN THIS MANUAL FOR CROWN PRODUCTS. 9/07



CROWN

PRODUCT REGISTRATION

Crown Audio, Inc.
 1718 W. Mishawaka Rd.
 Elkhart, IN 46517-9439
 Phone: 574-294-8000
 Fax: 574-294-8329
 www.crownaudio.com

Online registration is also available at <http://crownweb.crownintl.com/webregistration>.

Warranty is only valid within the country in which the product is purchased.

When this form is used to register your product, it may be mailed or faxed.

Crown Audio, Inc. Fax: 574-294-8329
 1718 W Mishawaka Rd
 Elkhart IN 46517

Please note that some information is required. Incomplete registrations will not be processed. * Indicates required information.

OWNER'S INFORMATION - PLEASE PRINT

* First name: _____ Middle initial: _____ * Last name: _____
 Company: _____
 * Mailing address: _____
 * City: _____ * State: _____ * Zip Code: _____
 * Country: _____ E-mail address: _____
 * Phone # (include area code): _____ Fax #: _____

PRODUCT INFORMATION

* MODEL	* SERIAL #	* PURCHASE DATE
e.g. IT8000, CDi1000, PCC160	e.g. 8000000000	mo/day/yr
_____	_____	____/____/____
_____	_____	____/____/____
_____	_____	____/____/____
_____	_____	____/____/____

Product purchased from: *(Business/Individual) _____ Country: _____

Comments: _____

CUT ON THIS LINE

THIS PAGE INTENTIONALLY LEFT BLANK



Crown Audio Factory Service Information

Shipping Address: Crown Audio Factory Service, 1718 W. Mishawaka Rd., Elkhart, IN 46517

PLEASE PRINT CLEARLY

SRA #: _____ (If sending product to Crown factory service.) Model: _____ Serial Number: _____ Purchase Date: _____

PRODUCT RETURN INFORMATION

Individual or Business Name: _____

Phone #: _____ Fax #: _____ E-Mail: _____

Street Address (please, no P.O. Boxes): _____

City: _____ State/Prov: _____ Postal Code: _____ Country: _____

Nature of problem: _____

Other equipment in your system: _____

If warranty is expired, please provide method of payment. Proof of purchase may be required to validate warranty.

PAYMENT OPTIONS

I have open account payment terms. Purchase order required. PO#: _____ COD

Credit Card (Information below is required; however if you do not want to provide this information at this time, we will contact you when your unit is repaired for the information.)

Credit card information:

Type of credit card: MasterCard Visa American Express Discover

Type of credit card account: Personal/Consumer Business/Corporate

Card # _____ Exp. date: _____ * Card ID #: _____

* Card ID # is located on the back of the card following the credit card #, in the signature area. On American Express, it may be located on the front of the card. This number is required to process the charge to your account. If you do not want to provide it at this time, we will call you to obtain this number when the repair of your unit is complete.

Name on credit card: _____

Billing address of credit card: _____

THIS PAGE INTENTIONALLY LEFT BLANK

THIS PAGE INTENTIONALLY LEFT BLANK



H A Harman International Company